

# Translation of the Original Installation Manual ISO FIT

ISOBUS Retrofit Harness

Item # 560650  
Version EN 2.1

April 2019

## **Imprint**

All rights reserved  
© Copyright by

Reichhardt GmbH Steuerungstechnik  
Hofgut Ringelshausen  
35410 Hungen / Germany

Phone +49 (0) 6043 - 9645 - 0  
Fax +49 (0) 6043 - 4365  
Web [www.reichhardt.com](http://www.reichhardt.com)  
E-mail [welcome@reichhardt.com](mailto:welcome@reichhardt.com)

This manual, even in extracts, may only be reprinted, copied or otherwise reproduced with the express permission of Reichhardt GmbH.

Any type of reproduction, distribution or storage on data storage devices in any form and type which has not been authorized by Reichhardt GmbH constitutes a violation of the applicable national and international copyright and will be prosecuted.

Individual figures may differ slightly from the actual product received. This does not have any effects on the function or operation.

All information, figures and technical data in this publication represent the latest version available at the time of publication. Changes to the product can be made at all times and without prior notice.

Responsible party for the content and layout of this publication: Reichhardt GmbH Steuerungstechnik

# Content

<b>1</b>	<b>General Information</b> .....	<b>1</b>
1.1	Reading and Observing the Manual .....	1
1.2	Understanding the Manual.....	1
1.3	Understanding Warnings .....	1
1.4	Warranty and Liability .....	2
1.5	Service and Repair.....	2
<b>2</b>	<b>For your Safety</b> .....	<b>3</b>
2.1	Intended Use .....	3
2.2	Service Personnel Requirements.....	3
2.3	Safety Instructions for Installation and Servicing .....	4
2.4	Safety Instructions for Electricians .....	5
2.5	Safety Instructions for Commissioning and Operation .....	6
2.6	Safety Instructions regarding Disposal .....	6
<b>3</b>	<b>System Components</b> .....	<b>7</b>
3.1	ISO FIT – Basic Kit (705211) .....	7
3.2	Optional Components .....	11
3.2.1	Overview .....	11
3.2.2	ISO FIT front socket (705212).....	12
3.2.3	ISO FIT Receiver Adapter (703433-00) .....	13
3.2.4	ISO FIT – TECU Kit (705213).....	13
<b>4</b>	<b>Installation</b> .....	<b>15</b>
4.1	Taking Preparations at the Vehicle .....	15
4.2	Connections of the ISO FIT ISOBUS Retrofit Harness .....	16
4.2.1	ISO FIT – Basic Kit (705211) .....	16
4.2.2	ISO FIT – Basic Kit (705211) including optional Components .....	17
4.3	Mounting the Rear Socket.....	19
4.4	Laying and Connecting the ISOBUS Main Harness.....	20
4.5	Mounting and Connecting the ISOBUS InCab Socket.....	23
4.6	Power Supply (Cabin).....	25
4.7	Mounting and Connecting the TECU (optional).....	27
4.8	Connect the ISO FIT Receiver Adapter (optional).....	28
4.9	Mounting and Connecting a Front Socket (optional) .....	29
4.10	Completing the Installation .....	31
<b>5</b>	<b>Commissioning</b> .....	<b>33</b>

**CONTENT**

<b>6</b>	<b>User Interface of the TECU (optional)</b> .....	<b>35</b>
6.1	Overview .....	35
6.2	Settings.....	36
6.2.1	Timeout Key Switch.....	37
6.2.2	Language Information .....	37
6.3	Service Menu .....	39
6.3.1	Enter Service Code/Overview.....	39
6.3.2	Setpoints 1 .....	40
6.3.3	Setpoints 2 .....	42
6.3.4	Sensor Signals.....	43
6.3.5	Rear Hitch In-Work Indication.....	47
6.3.6	Vehicle Speed.....	48
6.3.7	Diagnosis .....	48
6.4	Save/Reboot.....	49
6.5	Malfunction of the System .....	50
<b>7</b>	<b>Work and Storage Conditions</b> .....	<b>51</b>

# 1 General Information

This installation manual is intended for service personnel (e.g. agricultural machinery technicians) of agricultural machinery dealers or similar and describes the installation, commissioning and servicing of Reichhardt ISOBUS components for tractors and self-propelled agricultural machinery, etc.

## 1.1 Reading and Observing the Manual

Please precisely observe and comply with all information and instructions to ensure proper functioning of the Reichhardt ISOBUS components and to prevent personal injury and damage to property. In case of problems in understanding parts of this manual or for other support, please contact Reichhardt.

## 1.2 Understanding the Manual

### Dimensions

The dimensions in this manual correspond to the metric system. Instructions in English language do also consider the imperial system if required.

### Directions

The directions “right” and “left” are generally to be understood from the driver seat in the direction of travel.

### Figures

The figures shown in this manual only serve for reference. Figures for installation may deviate according to the vehicle model/equipment and the individual installation situation and do not have any influence on the functionality of the system. Software figures may also slightly deviate from actual displays due to different software versions and steering modes.

### Language

This manual is possibly available in other languages. For further information, please contact us via phone or e-mail.

## 1.3 Understanding Warnings

This is a safety alert symbol: 

When you see this symbol on the vehicle or in this manual, be alert to the potential for personal injury. Follow recommended precautions and safe operating practices. Please also note the blue notice signs for correct and damage-free installation/operation.



The signal word DANGER is used with the safety alert symbol to identify a hazardous situation that, if not avoided, will result in death or serious injury.



The signal word WARNING is used with the safety alert symbol to identify a hazardous situation that, if not avoided, could result in death or serious injury.



The signal word CAUTION is used with the safety alert symbol to identify a hazardous situation that, if not avoided, could result in minor or moderate injury.



The signal word NOTICE indicates important information that, if disregarded, can result in property damage or malfunction of the components or the vehicle. Follow these instructions to ensure long life and proper functionality of the components and the vehicle.

## 1.4 Warranty and Liability

Warranty or liability obligations apply according to the General Terms and Conditions of Reichhardt GmbH Steuerungstechnik. The General Terms and Conditions can be found at [www.reichhardt.com](http://www.reichhardt.com).

Reichhardt does not assume any liability for damage due to a not intended use.

### Use of non-approved accessories and spare parts

Exclusively accessories and spare parts approved by Reichhardt may be used for Reichhardt ISOBUS components. These are particularly designed for Reichhardt ISOBUS components and meet high requirements on safety and reliability. Reichhardt particularly points out that accessories or spare parts not approved by Reichhardt must not be used on Reichhardt systems. Otherwise, the safety and function of the system may be compromised. Additionally, personal injury or damage to property may occur due to malfunctions in the system. Reichhardt does not assume any liability for use of non-approved accessories or spare parts.

### Unauthorised modifications

If modifications that are not explicitly approved by Reichhardt are carried out at the system, all obligations for warranty as well as any liability by Reichhardt for potential system malfunctions become void. Additionally, the EU Declaration of Conformity (CE mark) or other regulatory approvals may become void. This also applies for removal of factory-applied seals or sealing paint.

## 1.5 Service and Repair

In case of questions on Reichhardt ISOBUS components and available system extensions or spare parts, please contact your local dealer or directly the manufacturer:

Always report any damage at the product without delay to your responsible dealer or directly to Reichhardt.

## 2 For your Safety

Please read the safety instructions carefully and completely. They contain important information which is essential for safe installation, commissioning, configuration, maintenance and operation of the Reichhardt ISO-BUS components. Failure to observe the safety instructions can result in personal injury and property damage and result in the loss of any claims for damages.

Besides the given instructions in this manual, please also follow the instructions of any further existing manuals and the regionally applicable regulations for occupational health and safety, accident prevention and road traffic.

### 2.1 Intended Use

ISOBUS components by Reichhardt are only designed for use on non-public roads controlled by persons working in agriculture and forestry, including special cultures (e.g. vineyard, fruit and vegetable cultivation), gardening and landscaping and municipal technology.

Any other use beyond this is considered improper and is therefore prohibited.

#### In addition applies

Intended use also includes compliance with the operating conditions prescribed by Reichhardt and the maintenance, service and repair instructions.

Reichhardt will not accept any liability for damage resulting from improper use. Any risks resulting from improper use are solely borne by the user.

The individual components must not come into contact with chemicals such as acids, lye, oils, lubricants or aggressive substances from the petrochemicals sector.

### 2.2 Service Personnel Requirements

Personnel concerned with installation, commissioning, servicing or temporary operation of Reichhardt ISOBUS components for one of these purposes must fulfil the following minimum requirements:

- They are of legal age
- They are in physical and mental condition to control the vehicle equipped with Reichhardt ISOBUS components.
- They must not be under the influence of medication, alcohol or drugs which may impair their ability to react in any way.
- They have completed the appropriate essential technical vocational training.
- They understand how the vehicle works and may drive it.
- They have read and understood this manual completely, understand how the ISOBUS components work and can carry out work on the vehicle and ISOBUS components safely and can recognize and avoid possible dangers and risks related to the work to be carried out by them.

## 2.3 Safety Instructions for Installation and Servicing

Installation and servicing require that the sequences are known.

If technically possible, installation and servicing of the Reichhardt ISOBUS components must always be carried out with the vehicle fully at standstill and with the engine switched off. The operator of the vehicle must ensure that the vehicle cannot be started unintentionally or against prior arrangement by unauthorised persons. As necessary, remove the ignition key.

If installation or servicing is required at the running vehicle which is equipped with Reichhardt ISOBUS components, only authorised personnel are allowed to access the danger zone after clear confirmation by the operator. These personnel have to be informed precisely on any potential dangers before entering the danger area. All tasks have to be precisely agreed on in advance by the operator and these personnel. Always ensure that hands, feet and clothing do not project into the danger area of driven components. Switch off all drive systems and de-pressurise the system at the dedicated operating equipment.

Also comply with the following installation and servicing regulations:

- Keep the workplace clean and dry.
- Do not work in potentially explosive atmospheres.
- Avoid sparking and open flames near the battery. There is a risk of explosion.
- Appropriately use and properly dispose of cleaning agents, substances and materials.
- When operating the vehicle, please be mindful of components which may have become hot.
- Remove any accumulations of lubricating grease, oil or dirt.
- Support the vehicle parts, which must be lifted to carry out installation or maintenance work, in a safe manner.
- Use a ladder or platform to be able to install, remove or maintain components in elevated positions. Make sure that you are standing in a stable and sure position and your hands cannot slip off.
- Do not assemble, disassemble or configurate components in elevated positions in wet or icy weather conditions.
- Please consider the safety instructions regarding electrics (see Chapter 2.4).
- Replace any worn or damaged parts.
- Report or repair any damage immediately.
- Always make sure that all parts are in a sound condition and have been installed properly. Electrical cables should not be pulled over sharp edges. This can damage the cables.
- Look out for damaged or incorrectly installed electrical cables. These may cause severe electric shocks.
- Obtain parts to be replaced (screws, hose lines, etc.) only via Reichhardt, to ensure proper function and safety of the vehicle and the ISOBUS components



## 2.4 Safety Instructions for Electricians

Before any work is to be carried out at the electrical system of the vehicle, the vehicle should be de-energised for safety. Switch off the battery at the main switch. If no switch is available or welding work is to be carried out at the vehicle or any other work near the battery, the battery should be disconnected.

The battery may present a hazard due to electric currents, a short circuit involving high-current intensity, leaking of battery fluid or an explosion. Severe burns may be the result. Always take the battery in and out of operation properly.

When removing and installing the battery, the following precautions must be observed:

- Remove rings, watches and metal objects.
- Use tools with insulated grips and handles.
- Do not place any tools or metal objects on the battery.
- When removing the battery, disconnect the NEGATIVE terminal first and then the POSITIVE terminal (see Fig. 1).
- Place the battery horizontally on a clean surface.
- When installing the battery, fasten it using the provided bracket.
- When installing the battery, connect the POSITIVE terminal first and then the NEGATIVE terminal.
- For additional installations, make sure that there is no contact with other metal objects.

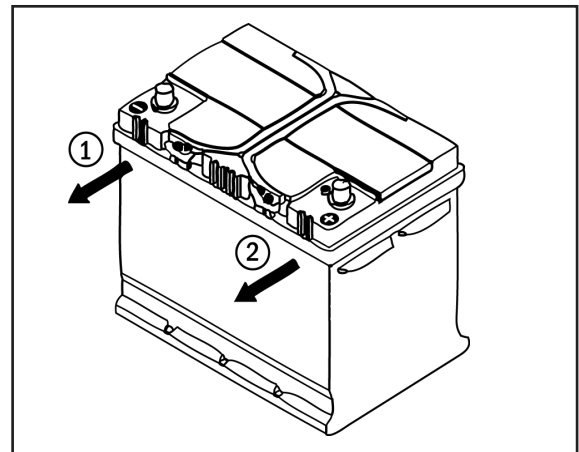

Fig. 1: Disconnecting the battery

## 2.5 Safety Instructions for Commissioning and Operation

Immediately switch off the Reichhardt ISOBUS components in dangerous situations or drive the vehicle manually to avoid personal injury or material damage.

Watch out for obstacles when using the ISOBUS components in order to prevent damage to the vehicle and other components.

Discontinue operations if it is no longer possible to detect obstacles or persons quickly enough as a result of poor visibility conditions.

To avoid personal injury and material damage during operation, follow the following instructions:

As soon as the vehicle is moving and the ISOBUS components are activated, nobody may remain in the danger zone (see Fig. 2).

The operator is obliged to stop the vehicle immediately as soon as persons enter the danger zone. Persons in the danger zone are exposed to the risk of serious or even fatal injury. Persons might be rolled over by the vehicle if there is a vehicle malfunction. The operator may only start the vehicle and activate the ISOBUS components again if there are no persons in the danger zone.

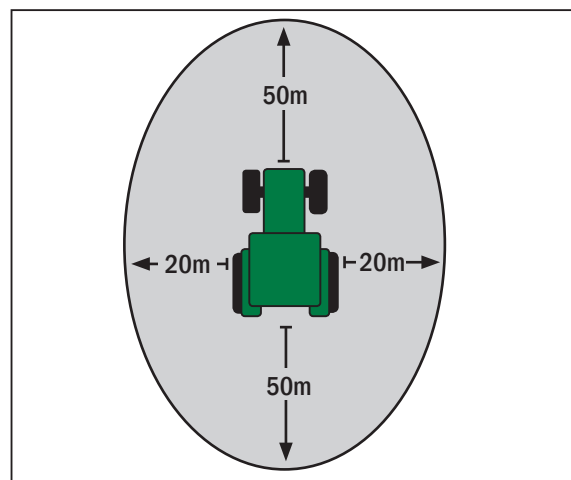

Fig. 2: Danger zone

## 2.6 Safety Instructions regarding Disposal

For disposal of the Reichhardt ISOBUS components, please observe the following safety regulations:

- Disassemble the ISOBUS components and sort the individual components according to their material structure.
- Please consult the responsible local authority or a dedicated waste management facility on disposal of the individual components. Some components are subject to treatment of hazardous waste.
- Dispose of all components according to applicable regulations.

### 3 System Components

For use of the *ISO FIT ISOBUS retrofit harness*, you need the *ISO FIT – basic kit*. You can also purchase additional optional components.

#### 3.1 ISO FIT – Basic Kit (705211)

The *ISO FIT – basic kit* contains the following components:

Quantity	Description
1	ISOBUS main harness (703428-00)
1	ISOBUS InCab adapter (703430-00)
1	ISOBUS mounting socket ISO 11783-2 – IBBC active (141570)
1	ISOBUS terminator TBC (110578)
1	Relay 12V 30/40A splash-proof (110305)
1	Relay 12V 70A splash-proof (110395)
1	Dual-ATC blade-type fuse adapter with tapping device (130333)
1	Bracket for ISOBUS socket IBBC (320664)
4	Socket head screw M6x20 with cylinder head DIN 912 (300095)
4	Self-locking nut M6 DIN 985-8 VZ (300142)
1	7.5A fuse, blade-type connector, brown (130061)

#### ISOBUS Main Harness (703428-00)

The ISOBUS main harness (see Fig. 3) connects all system components and ensures power supply for the system.

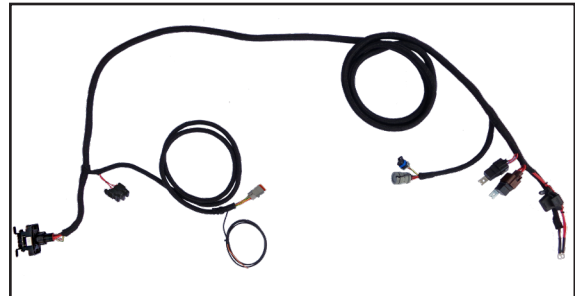

Fig. 3: ISOBUS main harness (figure contains additional components)

#### ISOBUS InCab Adapter (703430-00)

The ISOBUS InCab adapter (see Fig. 4) is connected to the ISOBUS main harness. It is the connector for an ISOBUS display unit (ISO-VT) or an ISOBUS control element (joystick ISO CONTROL).



Fig. 4: ISOBUS adapter InCab

**ISOBUS Mounting Socket ISO 11783-2 – IBBC active (141570)**

The *ISOBUS mounting socket – IBBC active* (see Fig. 5) is used as rear socket for connecting an ISO-BUS attachment.

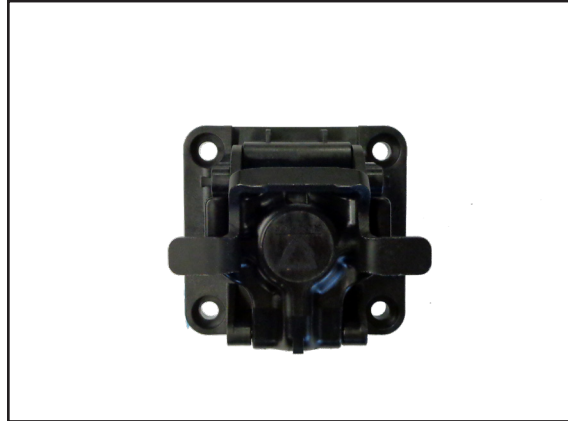

Fig. 5: ISOBUS mounting socket ISO 11783-2 – IBBC active

**ISOBUS Terminator TBC (110578)**

You must connect the terminator (see Fig. 6) to the X05A connector of the ISOBUS main harness in case you do not use a front socket.



Fig. 6: ISOBUS Terminator TBC

**Relay 12V 30/40A splash-proof (110305)**

The relay (see Fig. 7) is connected to the ISOBUS main harness and controls the power supply from the ECU Power unit.



Fig. 7: Relay 12V 30/40A, splash-proof

**Relay 12V 70A splash-proof (110395)**

The relay (see Fig. 8) is connected to the ISOBUS main harness and controls the power supply for terminal 30 and the power supply for the actuators and sensors.



Fig. 8: Relay 12V 70A, splash-proof

**Dual-ATC blade-type fuse Adapter with tapping Device (130333)**

The *Dual ATC blade-type fuse adapter* (see Fig. 9) is connected in the terminal box and in the cabin and establishes the ignition voltage supply through terminal 15.

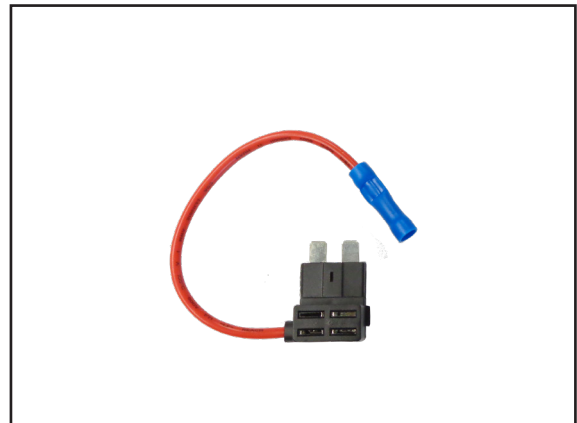

Fig. 9: Dual-ATC blade-type fuse adapter with tapping device

**Bracket for ISOBUS Socket IBBC (320664)**

The bracket (see Fig. 10) is required to assemble the rear socket at the vehicle.

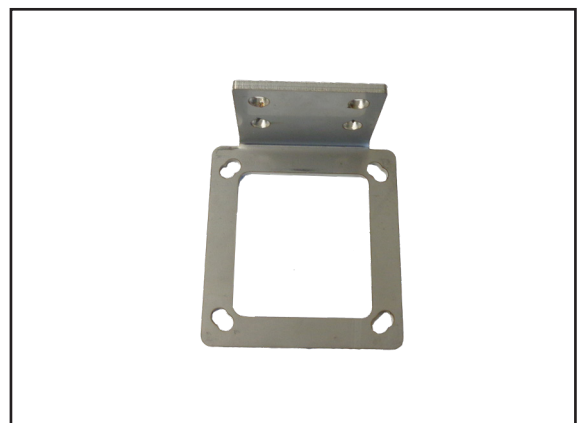

Fig. 10: Bracket for ISOBUS socket IBBC

**Screws / Nuts for ISOBUS Socket Bracket**

The screws and nuts listed below are required for fastening the ISOBUS mounting socket at the *IBBD ISOBUS socket bracket*.

- 4 x *Socket head screw M6x20 with cylinder head DIN 912* (300095) (see Fig. 11 – 1)
- 4 x *Self-locking nut M6 DIN 985-8 VZ* (300142) (see Fig. 11 – 2)

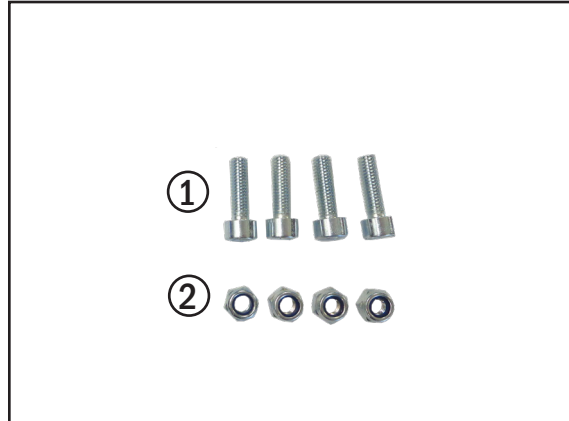

Fig. 11: Screws/nuts for ISOBUS socket bracket

**7.5A Fuse, Blade-Type Connector, brown (130061)**

The fuse (see Fig. 12) is inserted into the Dual blade-type fuse adapter and the assembly is connected in the fuse box inside the cabin of the vehicle.



Fig. 12: 7.5 A fuse for blade-type connector, brown

## 3.2 Optional Components

You can optionally extend the *ISO FIT – basic kit* by the *ISO FIT front socket*, the *ISO FIT receiver adapter* and the *ISO FIT – TECU kit* as required.

### 3.2.1 Overview

Quantity	Description
1	ISO FIT front socket (705212)
	1x ISOBUS harness for front socket (703429-00) 1x ISOBUS mounting socket ISO 11783-2 IBBC passive (142053) 1x bracket for ISOBUS socket IBBC (320664) 1x socket head screw M6x20 with cylinder head DIN 912 (300095) 1x self-locking nut M6 DIN 985-8 VZ (300142)
1	ISO FIT receiver adapter (703433-00)
1	ISO FIT – TECU kit (705213)
	1 x ISOBUS TECU adapter (703431-00) 1 x ISO FIT TECU (703640-00) 1 x ISOBUS TECU adapter – signal socket (703434-00) 2 x Hexagon head screw M6x35 DIN 933 8.8 galvanized (300384) 2 x Self-locking nut M6 DIN985-8 galvanized (300142) 4 x Washer M6 DIN 125 galvanized steel (300110) 2 x Self drilling screw with hexagon head DIN 7504-K galvanized 63x32 (300138)

### 3.2.2 ISO FIT front socket (705212)

#### ISOBUS Harness for Front Socket (703429-00)

By means of the *ISOBUS harness for front socket* (see Fig. 13) you can operate a front socket in the vehicle in addition to the rear socket. The harness is directly connected to the *ISOBUS main harness*.

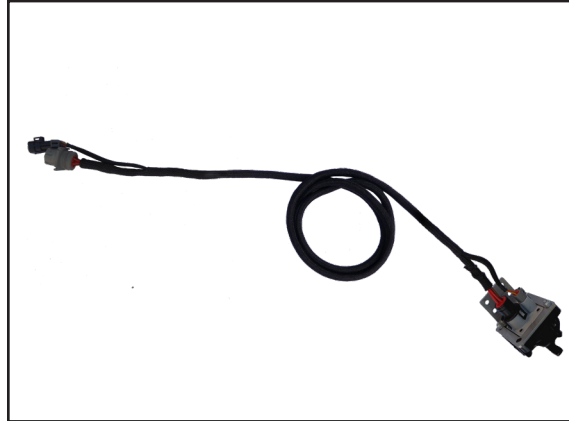

Fig. 13: ISOBUS harness for front socket (socket not included)

#### ISOBUS Mounting Socket ISO 11783-2 - IBBC passive (142053)

The *IBBC ISOBUS mounting socket, passive* (see Fig. 14) is assembled in the vehicle as front socket.



Fig. 14: ISOBUS mounting socket ISO 11783-2 - IBBC passive

#### Bracket for ISOBUS Socket IBBC (320664)

The bracket (see Fig. 15) is required for assembling the front socket to the vehicle.

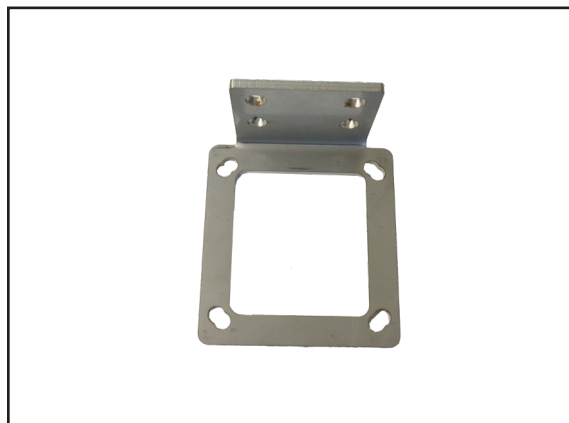

Fig. 15: Bracket for ISOBUS socket IBBC



### Screws / Nuts for ISOBUS Socket Bracket

The screws and nuts listed below are required for assembly of the *IBBC ISOBUS socket bracket* for the front socket.

- 4 x *Socket head screw M6x20 with cylinder head DIN 912 (300095)* (see Fig. 16 - 1)
- 4 x *Self-locking nut M6 DIN 985-8 VZ (300142)* (see Fig. 16 - 2)



Fig. 16: Screws/buts for ISOBUS socket bracket

### 3.2.3 ISO FIT Receiver Adapter (703433-00)

The *ISO FIT receiver adapter* (see Fig. 17) is connected to the *ISOBUS main harness* between connector X03A of the main harness and the *ISOBUS Adapter InCab* and is required for integration of a GPS receiver.

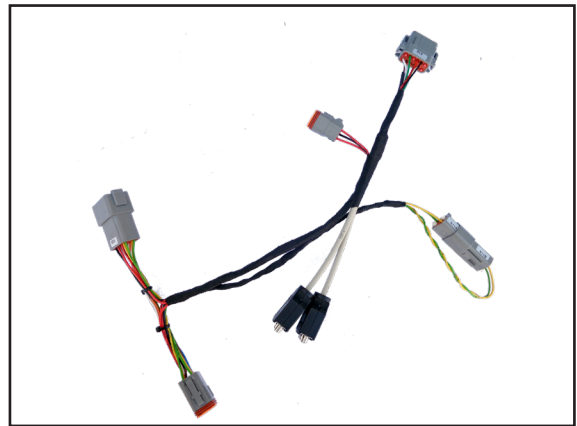

Fig. 17: ISO FIT receiver adapter

### 3.2.4 ISO FIT - TECU Kit (705213)

#### ISOBUS TECU Adapter (703431-00)

The adapter (see Fig. 18) will be connected between the *ISOBUS main harness* and the *ISOBUS InCab adapter*. It is required to connect the *ISO FIT TECU*.

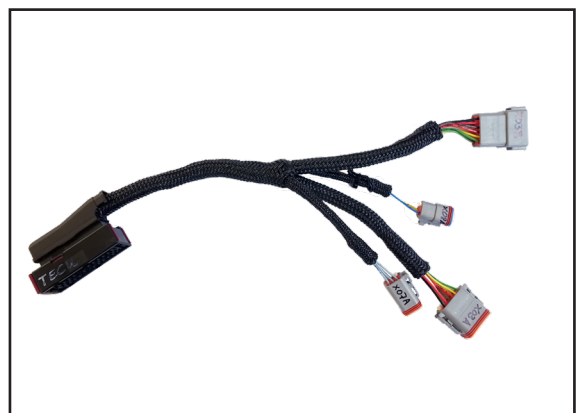

Fig. 18: ISOBUS TECU adapter

### ISO FIT TECU (703640-00)

The TECU (see Fig. 19) provides other ISOBUS applications with engine speed and signal socket data.



Fig. 19: ISO FIT TECU

### ISOBUS TECU Adapter – Signal Socket (703434-00)

The adapter (see Fig. 20) connects the signal socket with the *ISOBUS TECU adapter* and therefore with the other ISO FIT components.



Fig. 20: ISOBUS TECU adapter – signal socket

### Components for Mounting the TECU

The screws, nuts and washers are required to mount the TECU in the vehicle:

- 2 x Hexagon head screw M6x35 DIN 933 8.8 galvanized (300384) (see Fig. 21 – 1)
- 2 x Self-locking nut M6 DIN985-8 galvanized (300142) (see Fig. 21 – 2)
- 4 x Washer M6 DIN 125 galvanized steel (300110) (see Fig. 21 – 3)
- 2xSelf drilling screw with hexagon head DIN 7504-K galvanized 63x32 (300138) (see Fig. 21 – 4)

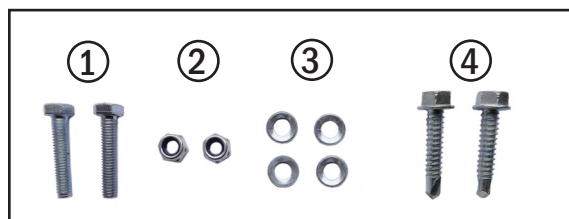

Fig. 21: Components for mounting the TECU

## 4 Installation

This chapter describes installation of the individual system components. The installation requirements and figures may differ, depending on the model and equipment of the vehicles. Therefore, the installation requirements shall be merely considered recommendations.

The reference installation for this manual has been performed using the *Massey Ferguson MF 5600* vehicle model.



Risk of injury from electrical currents and short circuits!  
De-energize the machine before starting any installation work.

### 4.1 Taking Preparations at the Vehicle

Remove the right rear wheel (see Fig. 22). For this purpose, follow the work steps and notices described in the vehicle's manual.

Subsequently, professionally support the vehicle in accordance with the instructions given in the manual of the vehicle.



Fig. 22: Remove the right rear wheel

Remove the covers and panels from the lateral console to install the cable harness. Also open the fuse box cover inside the vehicle cabin to obtain access to the power distribution unit (see Fig. 23).



Fig. 23: Lining from side console removed

## 4.2 Connections of the ISO FIT ISOBUS Retrofit Harness

The following describes how to connect the individual connections of the *ISO FIT ISOBUS retrofit harness* to each other and to the vehicle.

### 4.2.1 ISO FIT – Basic Kit (705211)

The individual cables of the *ISOBUS main harness* (703428-00) must be connected as follows (see also Fig. 24):

- BAT- → Ground (terminal 31)
- BAT+ → Voltage (terminal 30)
- XK01 → Relay 70A power supply for terminal 30 (110395)
- XK02 → Relay 30/40A, ECU Power (110305)
- X04A → (remains unconnected)
- X05A → (remains unconnected)
- X03A → ISOBUS InCab adapter (703430-00) → ISO-VT, Joystick, etc.
- X06 → Ignition voltage (terminal 15)
- X01A → PWR – Rear socket (141470)
- X02A → CAN bus – Rear socket (141470)

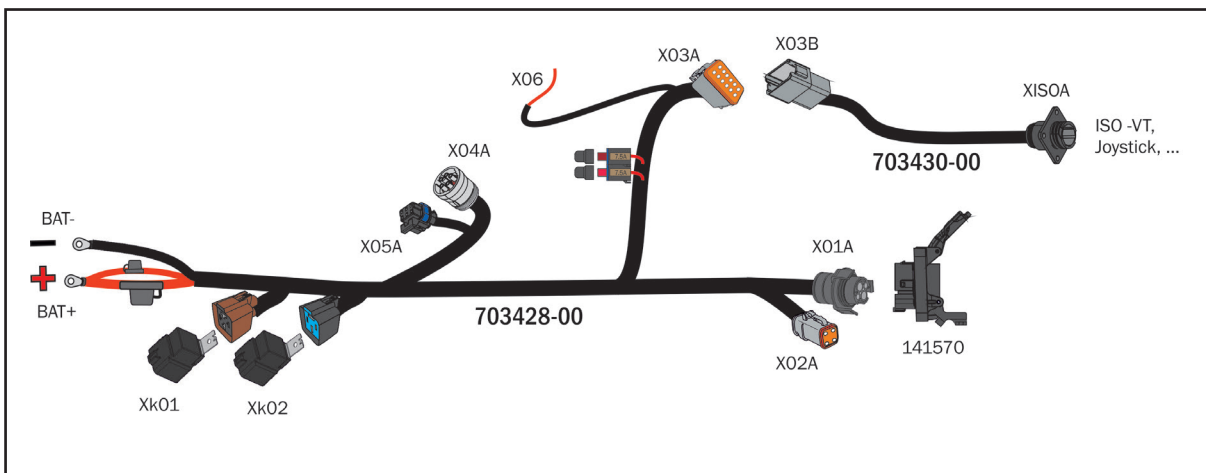

Fig. 24: ISO FIT – basic kit

### 4.2.2 ISO FIT – Basic Kit (705211) including optional Components

The ISO FIT ISOBUS retrofit harness can be extended with the following components:

- ISO FIT front socket (705212),
- ISO FIT receiver adapter (703433-00) and
- ISO FIT – TECU kit (705213).

The ISO FIT front socket has to be connected to connections X04A and X05A of the ISOBUS main harness (703428-00).

The ISO FIT receiver adapter and the ISO FIT – TECU kit will be connected between the connection X03A of the ISOBUS main harness (703428-00) and the connection X03B of the ISOBUS InCab adapter (703430-00) (see Fig. 25).

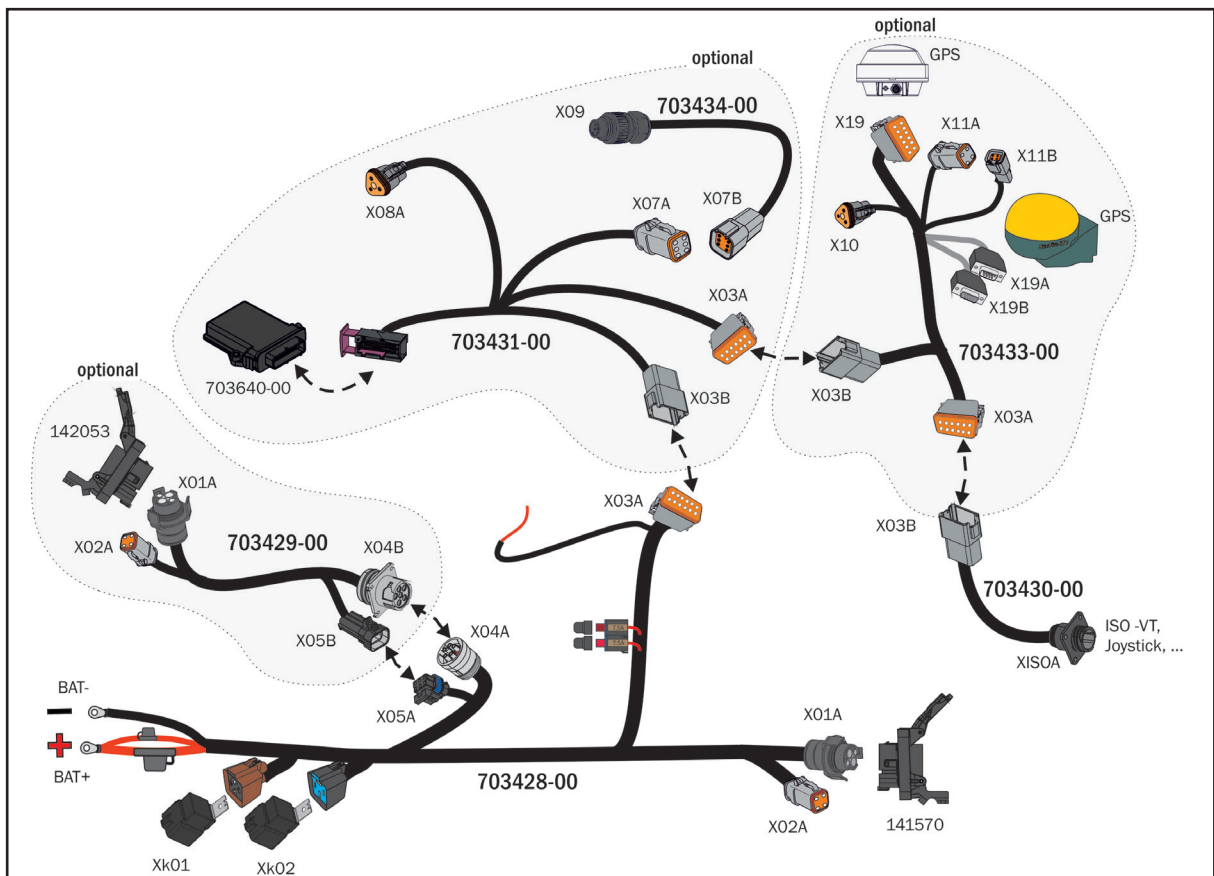

Fig. 25: ISO FIT – basic kit including optional components

## CHAPTER INSTALLATION

By using optional components the individual connections of the *ISOBUS main harness* (703428-00) must be connected as follows:

- BAT- → Ground (terminal 31)
- BAT+ → Voltage (terminal 30)
- XK01 → Relay 70A power supply for terminal 30 (110395)
- XK02 → Relay 30/40A, ECU Power (110305)
- X04A → ISOBUS harness for front socket CAN BUS (703429-00)
  - ↳ PWR – ISOBUS mounting socket passive (142053)
- X05A → ISOBUS harness for front socket CAN BUS (703429-00)
  - ↳ CAN BUS – ISOBUS mounting socket passive (142053)
- X03A → X03B – ISOBUS InCab adapter (703430-00) → ISO-VT, Joystick, etc.
- X06 → Ignition voltage (terminal 15)
- X01A → PWR – Rear socket (141470)
- X02A → CAN bus – Rear socket (141470)
- X03A → X03B – ISOBUS TECU adapter (703431-00)

The connections of the *ISOBUS TECU adapter* (703431-00) must be connected as follows:

- X03B → X03A – ISOBUS main harness (703428-00)
- TECU → ISO FIT TECU (703640-00)
- X08A → Engine CAN bus (if accessible)
- X07A → ISOBUS TECU adapter – signal socket (703434-00) → Signal socket of the vehicle
- X03A → X03B – ISO FIT receiver adapter (703433-00)

The connections of the *ISO FIT receiver adapter* (703433-00) must be connected as follows:

- X03B → X03A – ISOBUS TECU adapter (703431-00)
- X11B → CAN bus interface for JD receiver
- X19A → Serial port A, GPS data RS232
- X19B → Serial port B, GPS data RS232
- X19 → ISO FIT receiver adapter (703433-00) → GPS receiver serial
- X10 → Power supply for receiver
- X11A → CAN bus interface for JD receiver
- X03A → ISOBUS InCab adapter (703430-00) → ISO-VT, Joystick, etc.

### 4.3 Mounting the Rear Socket

#### Mounting the bracket for the ISOBUS socket

For assembly of the rear socket, you first need to mount the *bracket for the ISOBUS socket IBBC* (320664). The bracket is fixed to the rear of the vehicle frame. You may also use available drilled holes for mounting the bracket (see Fig. 26). If the holes available in the frame are not suitable, you need to drill some to fit your bracket.

**NOTICE** Make sure not to drill any holes into load-bearing or moving vehicle parts or units such as the motor block, the gearbox, or the hydraulic unit.

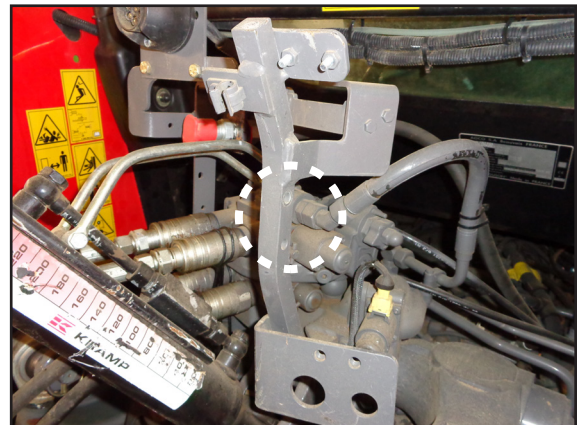

Fig. 26: Example for mounting position bracket for ISOBUS socket

Take the *bracket for ISOBUS socket IBBC* and fix it to the frame. For fixing, use two hexagon head screws (M8) and two nuts (M8) (not included in the scope of delivery) see Fig. 27).

**NOTICE** The mounting position illustrated in Fig. 27 is one of a number of different mounting options. You can mount the bracket to the vehicle to suit your respective conditions.

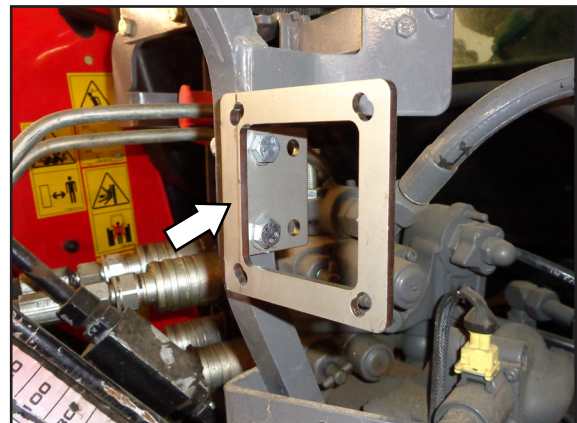

Fig. 27: Bracket for ISOBUS socket mounted

#### Installation of the ISOBUS mounting socket, active

Take the *ISOBUS mounting socket IBBC, active* (141570) and insert it into the *bracket for ISOBUS socket IBBC* (see Fig. 28).

**NOTICE** When inserting the socket, make sure that the protective cover can still be opened upwards. With any other mounting methods, water may get into the socket.

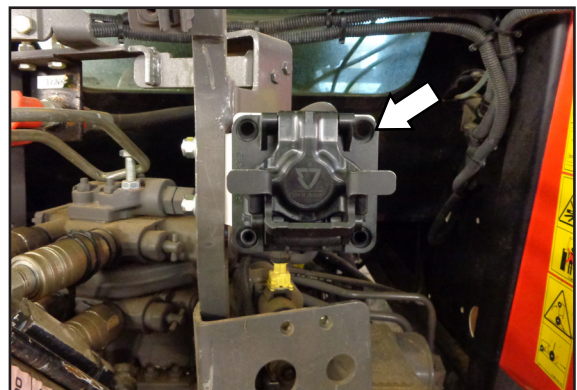

Fig. 28: Installing the ISOBUS mounting socket, active

For fixing the ISOBUS mounting socket IBBC, active, use the four socket head screws (M6x20) and the four self-locking nuts (M6) included in the ISO FIT - basic kit (705211). Screw-fix the socket to the bracket by the four drilled holes as provided (see Fig. 29).

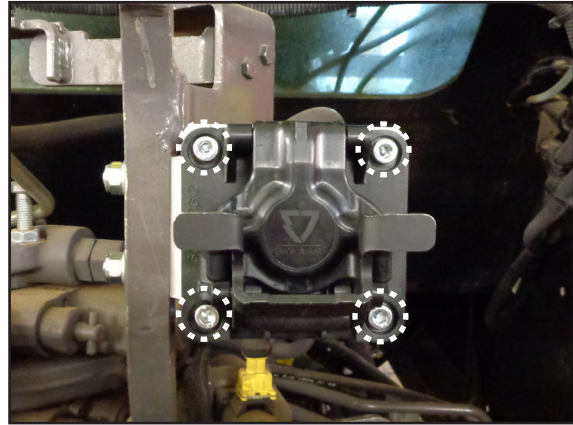

Fig. 29: ISOBUS mounting socket, active, installed

## 4.4 Laying and Connecting the ISOBUS Main Harness

### Laying the main harness along the vehicle frame

Lay the *ISOBUS main harness* (703428-00) starting from the rear socket routing it along the vehicle frame towards the front to the battery (see Fig. 30 and Fig. 31).

**NOTICE**

If the battery of the vehicle is located very far to the front, make sure to only lay a length of 4.5 m of cable between the rear socket and the battery to maintain a wiring and connecting reserve of 0.5 m.

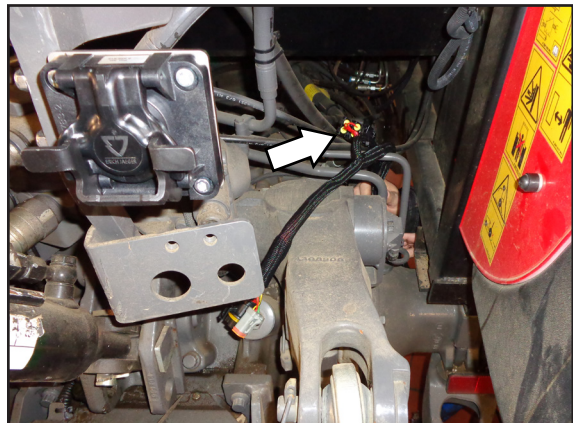

Fig. 30: Wiring the ISOBUS main harness

Use the shortest cable routes feasible and make sure that there are no obstacles.

**NOTICE**

Lay the harness carefully and accurately. Make sure that cables do not come in contact with sharp edges. Use cable ties to fix the harness. Cable ties and tie bases are not included in the scope of delivery.

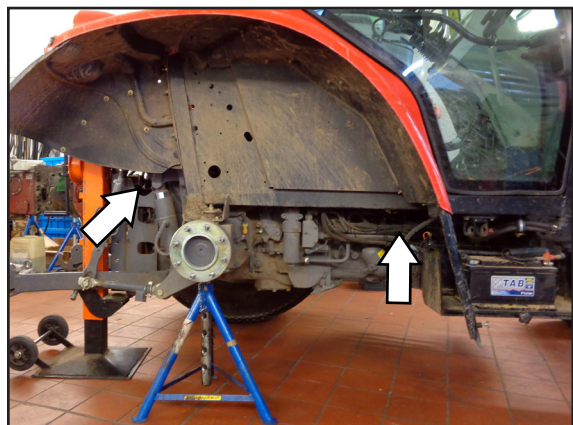

Fig. 31: Wiring the ISOBUS main harness



### Connecting the rear socket

Connect the connections X01A and X02A to the *ISO-BUS mounting socket – IBBC active* (see Fig. 32).

**NOTICE**

Make sure that the lock with the triangle is located at the top on the connector X01A.

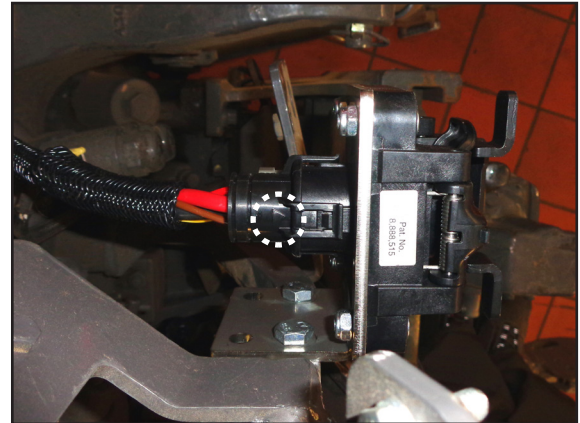

Fig. 32: Connecting the rear socket

### Routing the harness into the vehicle cabin

Select a suitable cabin lead-in to guide the X03A connector of the ISOBUS main harness into the cabin of the vehicle (see Fig. 33).

The cable lead-in should have a minimum diameter of 25 mm.

**NOTICE**

Lay the harness carefully and accurately. Make sure that cables do not come in contact with sharp edges. Use cable ties to fix the harness. Cable ties and tie bases are not included in the scope of delivery.

If your vehicle is equipped with cabin suspension, this must be taken into account when fixing the cable.



Fig. 33: Cable lead-in into the cabin

If the 12-pin Deutsch terminal block of the X03A connector is too big for the cable lead-in, you can remove it and insert the cable into the cabin. For that purpose, please proceed as follows (see Fig. 34):

- Using a flat-tip screwdriver, carefully loosen the orange protective bit from the terminal block (see Fig. 34).
- Then, using a pair of long nose pliers, carefully loosen the latch, press the individual pins out of the terminal and pull out to the back.

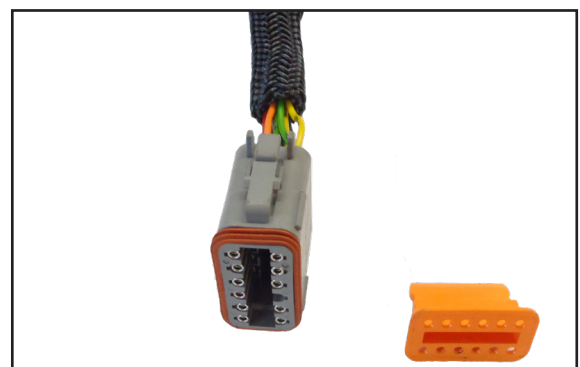

Fig. 34: Removing the X03A terminal

CHAPTER INSTALLATION

After routing the X03A connector into the vehicle cabin, you need to re-connect the terminal and assign the pins.

Insert the pins of the X03A connector into the terminal block as follows (see Fig. 35):

- |                    |   |             |
|--------------------|---|-------------|
| X03A/1 (green)     | ➔ | Position 1  |
| X03A/2 (yellow)    | ➔ | Position 2  |
| X03A/3 (red)       | ➔ | Position 3  |
| X03A/4 (brown)     | ➔ | Position 4  |
| X03A/5 (red)       | ➔ | Position 5  |
| X03A/6 (black)     | ➔ | Position 6  |
| X03A/7 (blue) REL1 | ➔ | Position 7  |
| X03A/8 (blue) REL2 | ➔ | Position 8  |
| not assigned       | ➔ | Position 9  |
| X03A/10 (orange)   | ➔ | Position 10 |
| X03A/11 (yellow)   | ➔ | Position 11 |
| X03A/12 (green)    | ➔ | Position 12 |

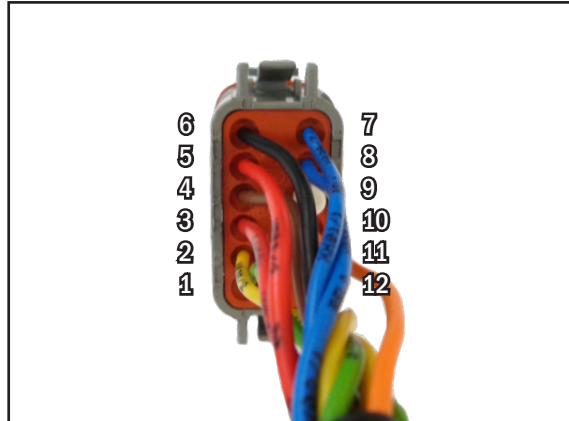

Fig. 35: Pin assignment of X03A terminal

When the pins are re-assigned to terminal X03A, re-insert the orange secondary lock (see Fig. 36).

Lay the excess cable lengths in a suitable position and form a loop (i.e. around the battery), which you must fix using cable ties (see Fig. 37 - 1).

**NOTICE** Make sure that the cable ties do not chafe the cables. That may cause damage of the cable.

If no front socket is retrofitted, the X04A and X05A connectors shall remain underneath the battery cover (see Fig. 37 - 2).

In the event that you retrofit a front socket, you need to find or create a suitable cable lead-in to connect the *ISOBUS harness for front socket* to the X04A and X05A connectors.



Fig. 36: X03A terminal re-assigned and harness routed into the cabin



Fig. 37: Lay excess cable in loops

## 4.5 Mounting and Connecting the ISOBUS InCab Socket

The *ISOBUS InCab adapter* (703430-00) includes an ISOBUS InCab socket, which needs to be mounted in the cabine.

You should preferably install the ISOBUS InCab socket in the right side console. If available, you can use a free connection position for the socket (see Fig. 38) or you drill a new connection position (minimum diameter 24mm).

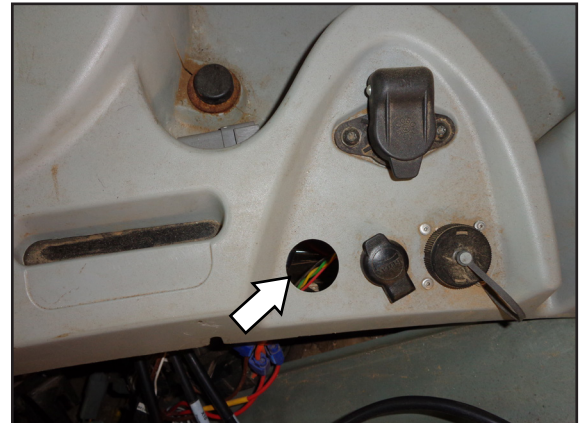

Fig. 38: Connection position in the side console

For installation of the ISOBUS InCab socket, the X03B connector plug must be removed. For that purpose, please proceed as follows (see Fig. 39):

- Carefully remove the green secondary lock from the plug. Use a pair of long nose pliers for that (see Fig. 39).
- Using a pair of long nose pliers carefully loosen the latch and pull each pin out of the plug individually.

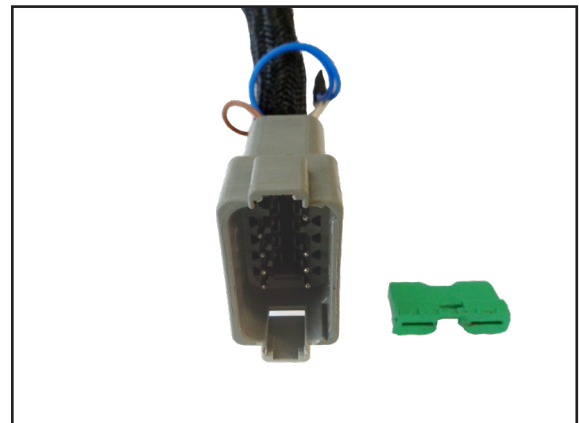

Fig. 39: Removing the X03B terminal

After removing the individual pins, route the cable through the opening of the connection position and insert the socket (see Fig. 40).

After inserting the InCab socket, the X03B terminal must be re-assigned.



Fig. 40: InCab socket installed

Insert the pins of terminal X03B of the *ISOBUS InCab adapter* into the terminal as follows (see Fig. 41):

X03B/1 (green) CAN L In	➔	Position 1
X03B/2 (yellow) CAN H In	➔	Position 2
not assigned	➔	Position 3
X03B/4 (brown)	➔	Position 4
X03B/3 (red)	➔	Position 5
not assigned	➔	Position 6
X03B/7 (blue) REL1	➔	Position 7
X03B/8 (blue) REL2	➔	Position 8
not assigned	➔	Position 9
X03B/10 (orange)	➔	Position 10
X03B/11 (yellow) CAN L Out	➔	Position 11
X03B/12 (green) CAN H Out	➔	Position 12

For fixing of the ISOBUS InCab socket in the console, use four screws (M3) and nuts (M3) (not included in the scope of delivery). Shift the ISOBUS InCab socket into the required position and pre-drill the holes for the screw connection. Subsequently fix the socket as described (see Fig. 42).

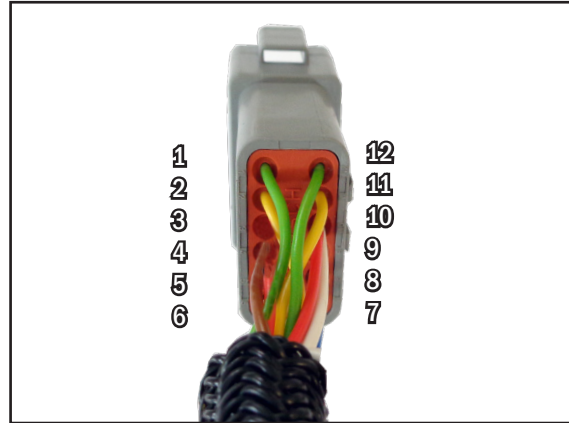

Fig. 41: Pin assignment of X03B terminal

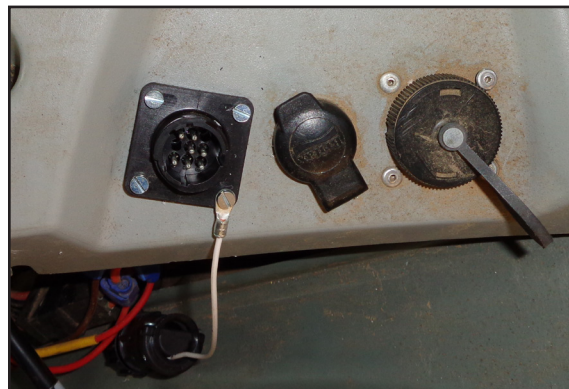

Fig. 42: InCab socket screw-fixed

Route the X03B connector of the *ISOBUS InCab adapter* from the mounted InCab socket (see Fig. 43 - 1) underneath the side console to the front towards the X03A connector of the main harness (see Fig. 43 - 2).

**NOTICE**

Take utmost care when laying the cable. Make sure that cable does not come in contact with sharp edges. Use cable ties to fix the cables. Cable ties and tie bases are not included in the scope of delivery.

Only connect the two connectors if the X06 ignition connection cable has been laid and wired with the fuse box. In that way you can be more flexible in using the reserve lengths of the cable.

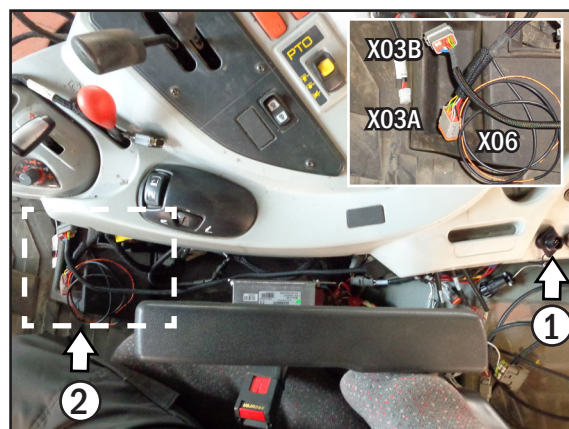

Fig. 43: Route cables underneath the side console

## 4.6 Power Supply (Cabin)

To establish the voltage supply for ignition, the connection cable for ignition X06 must be wired to the fuse box (see Fig. 43 and Fig. 44).

**NOTICE**

Take utmost care when laying the cable. Make sure that cable does not come in contact with sharp edges. Use cable ties to fix the cables. Cable ties and tie bases are not included in the scope of delivery.

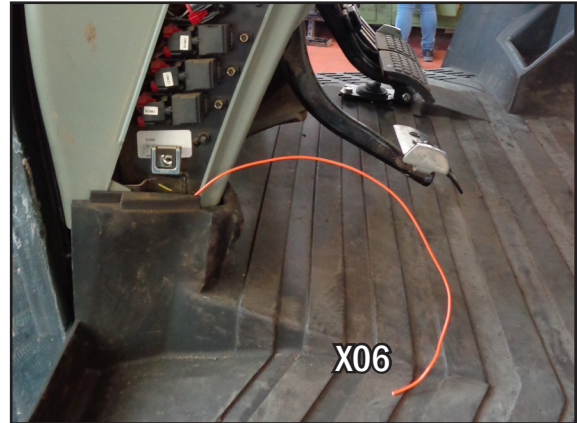

Fig. 44: Cable routed out of the floor lining

Then, attach the *Dual-ATC blade-type fuse Adapter with tapping Device* (130333) to connection X06. For that purpose, use a pair of cable crimping pliers. At first, strip the wires of the X06 connection cable by removing the cable insulation material. Then, connect the blade-type fuse adapter with the connection cable by means of the cable crimping sleeve (see Fig. 45). Use a cable crimping tool for the attachment.

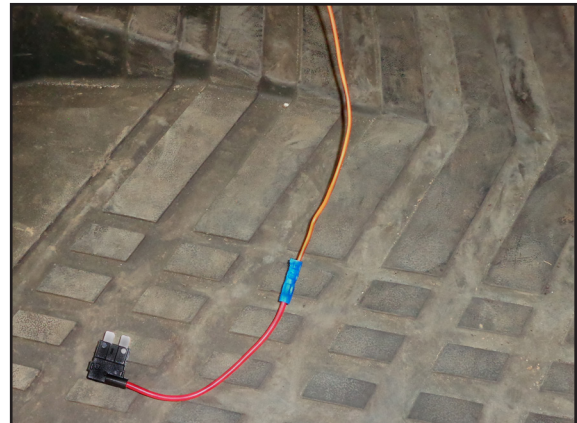

Fig. 45: Blade-type adapter Dual-ATC mounted

Remove the 30A fuse of the 3-pin power socket, that establishes protection of the ignition voltage at the power socket (see Fig. 46).



Fig. 46: Removing the fuse of the 3-pin power socket

Insert the 30A fuse that was removed from the fuse box into the lower connection position of the blade-type fuse adapter. In the uppermost position of the adapter, insert the *7.5A Fuse, Blade-Type Connector, brown (130061)* from the *ISO Fit – basic kit* (see Fig. 47).

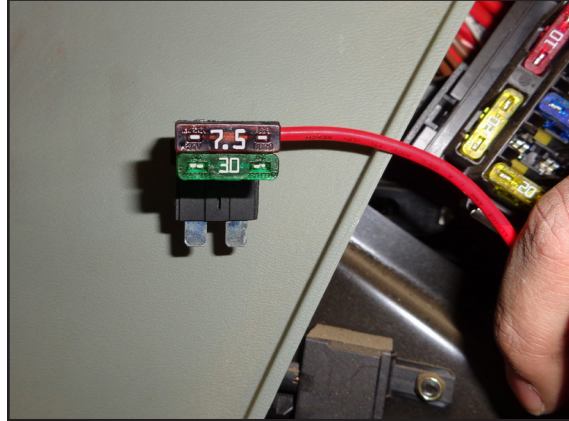

Fig. 47: Inserting 7.5A and 30A fuses into the blade-type fuse adapter

Insert the blade-type fuse adapter equipped with two fuses, 7.5A and 30A, to the connection position of the previously removed fuse in the fuse box (see Fig. 48).

Then, close the fuse box.



Fig. 48: Connect the connection cable with the blade-type fuse adapter

## 4.7 Mounting and Connecting the TECU (optional)

### Connecting the TECU to the ISOBUS TECU Adapter and Mounting of the TECU

Take the TECU and the *ISOBUS TECU adapter* (703431-00).

Insert the large connector of the *ISOBUS TECU adapter* into the TECU connector and lock it by fully inserting the red slider in the connector (see Fig. 49 – 1).

Take the supplied screws, nuts and washers and install the TECU in a suitable place in the cabin (see Fig. 49 – 2). It may be necessary to attach a bracket.

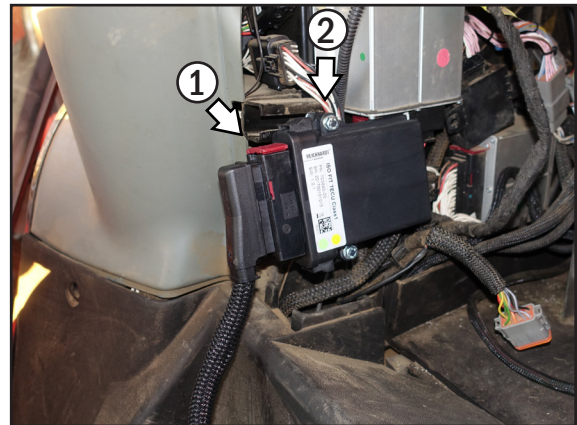

Fig. 49: Connecting the TECU to the ISOBUS TECU adapter and installing in the vehicle

### Connecting the ISOBUS TECU Adapter to the Main Harness and the Vehicle

If the vehicle has a signal socket, you can read out the data transmitted there, using the TECU.

Connect the *ISOBUS TECU adapter – Signal Socket* (703434-00) to connector X07A of the *ISOBUS TECU adapter* and to the signal socket of the vehicle.

Connect the *ISOBUS TECU adapter* between the X03A connector of the *ISOBUS main harness* (see Fig. 50 – 1) and X03B of the *ISOBUS InCab adapter* (703430-00) (see Fig. 50 – 2).

**NOTICE**

If you also use the optional *ISO FIT receiver adapter* (703433-00), the *ISOBUS InCab adapter* will be placed between the X03A connector of the *ISOBUS main harness* and X03B of the *ISO FIT receiver adapter*.

Via connector X08A of the *ISOBUS TECU adapter*, you can transmit the signal of the motor CAN bus to the TECU.



Fig. 50: Connecting the ISOBUS TECU adapter to the main harness and the vehicle

### 4.8 Connect the ISO FIT Receiver Adapter (optional)

If you want to integrate a GPS receiver into the ISO-BUS system, you require the *ISO FIT receiver adapter* (703433-00).

Connect the adapter between connector X03A of the *ISOBUS main harness* (see Fig. 51 – 1) and connector X03B of the *ISOBUS InCab adapter* (see Fig. 51 – 2).

**NOTICE** If you also use the optional *ISO FIT - TECU kit* (705213), the receiver adapter is connected between connector X03A of the *ISOBUS TECU adapter* (703431-00) and X03B of the *ISOBUS InCab adapter* (703430-00).

When using an RGS receiver, connect it via a corresponding connection cable to the serial port X19 of the *ISO FIT receiver adapter* (see Fig. 52).

Receivers operating on the CAN J1939 or NMEA 2000 protocols (e.g., John Deere StarFire 3000) must be connected to the X11A/X11B and X10 connectors of the *ISO FIT receiver adapter* (see Fig. 53).

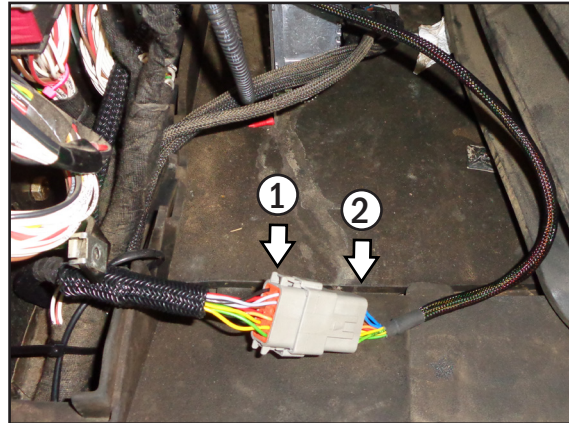

Fig. 51: Connection of the ISO FIT receiver adapter

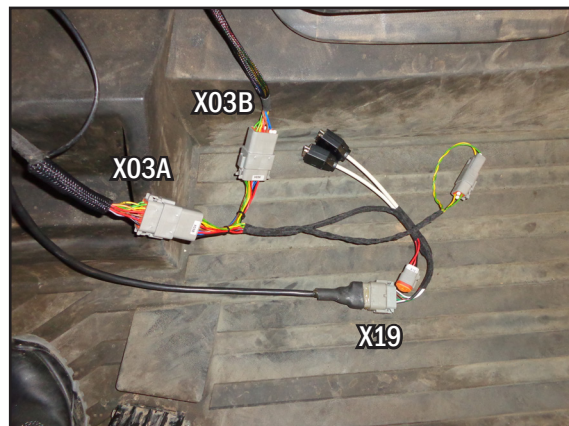

Fig. 52: ISOBUS InCab adapter connected in case of use of a serial receiver

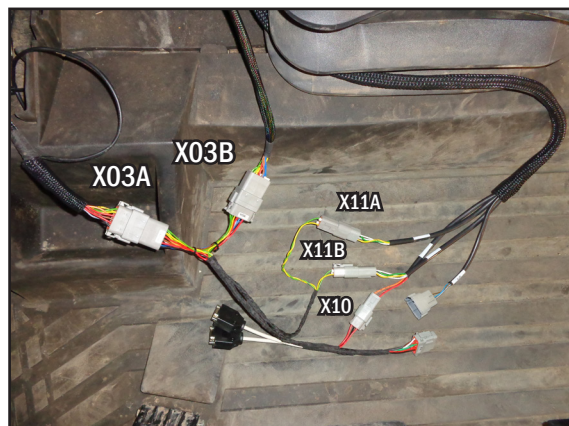

Fig. 53: Use of a receiver with CAN J1039 or NMEA 2000



## 4.9 Mounting and Connecting a Front Socket (optional)

It is optionally possible to add a front socket to a vehicle retrofitted with ISOBUS.

For that purpose you need the *ISO FIT front socket* (705212). Choose a suitable point to mount the *bracket for ISOBUS socket IBBC* (320664) using two hexagon head screws and two nuts (M8) (not included in the scope of delivery) (see Fig. 54).

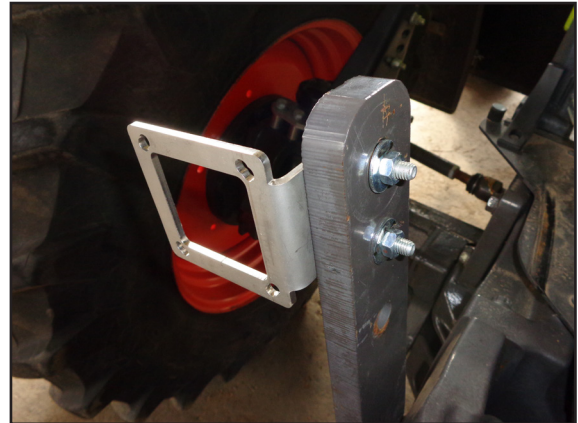

Fig. 54: Bracket for front socket mounted

Take the *ISOBUS mounting socket ISO 11783-2 IBBC passive* (142053). Position it in the bracket and fix the mounting socket using four hexagon socket head screws (M6x20) with cylinder head and four self-locking nuts (M6) (see Fig. 55).



Fig. 55: Front socket mounted

Take the *ISOBUS harness for front socket* (703429-00) and connect the two X01A and X02A connectors to the mounting socket (see Fig. 56).

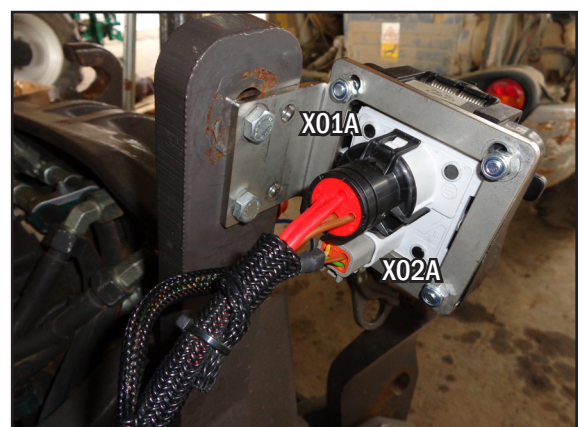

Fig. 56: Front socket connected to ISOBUS harness for front socket

Route the *ISOBUS* harness for front socket along the vehicle frame towards the battery to the terminal boxes, X04A and X05A, of the main harness (see Fig. 57).

**NOTICE**

Lay the harness carefully and accurately. Make sure that cables do not come in contact with sharp edges. Use cable ties to fix the cables. Cable ties and tie bases are not included in the scope of delivery.



Fig. 57: X05A and X04A terminal of the main harness

Connect the *ISOBUS* harness for front socket (see Fig. 58 - 1) to the connectors X04B and X05B of the main harness (see Fig. 58 - 2).

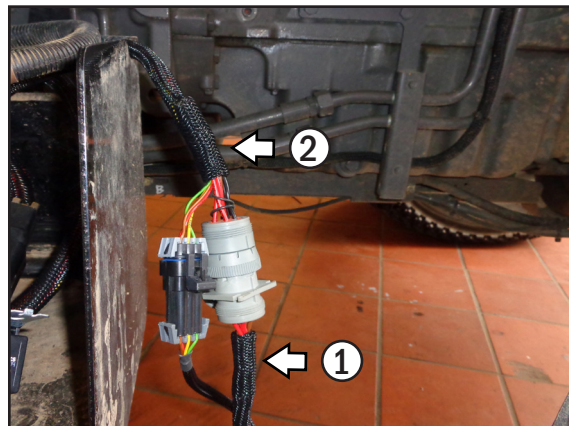

Fig. 58: ISOBUS harness for front socket connected to main harness

## 4.10 Completing the Installation

### Power Supply (Battery of the Vehicle)

To establish the power supply for the system, the main harness must be connected to the battery of the vehicle. For this, the battery must be disconnected from the vehicle, if this has not already been done.

Connect the main harness with the positive pole of the battery via the BAT+ terminal block and with the negative pole of the battery via the BAT- terminal block in the given order (positive first, then negative). For that purpose, use the available terminal lugs (see Fig. 59).



**Risk of injury due to short circuits!**  
 Only re-connect the battery after you have connected the BAT+ and BAT- terminals to the pole lugs.



Fig. 59: Power connection to vehicle battery

### Inserting relays

At terminal XK01 of the main harness connect the *relay 12V 70A, splash-proof (110395)* (see Fig. 60 - 1) and at terminal XK02 connect the *relay 12V 30/40A, splash-proof (110305)* (see Fig. 60 - 2).

- XK01 (brown)    ➔    Relay 12V 70A
- XK02 (black)   ➔    Relay 12V 30/40A

After installation, secure the relays using cable ties (not included in the scope of delivery).

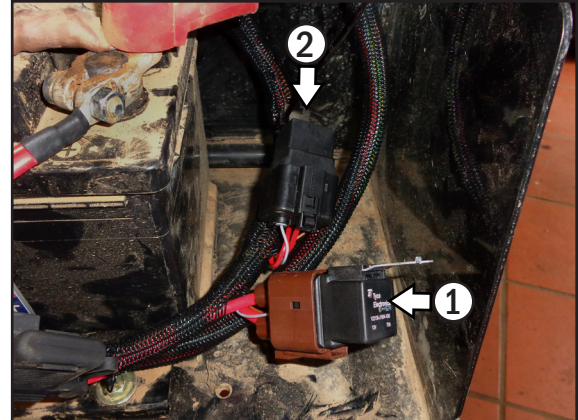

Fig. 60: Relays 70A and 30/40A installed

### Connecting the ISOBUS terminator TBC

In case that no front socket is installed, you need to connect an *ISOBUS terminator TBC* (110578) at terminal X05A of the main harness (see Fig. 61).

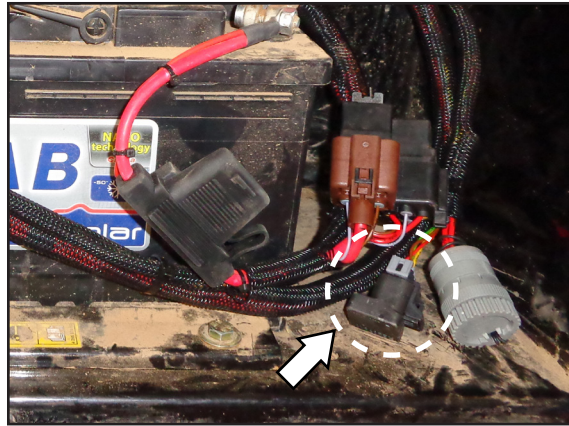

Fig. 61: ISOBUS terminator TBC connected

### Fixing and securing the cables

Check the cable routes and secure the wired cables using cable ties after having connected all the components (see Fig. 62).

**NOTICE**

Take utmost care when laying the cables. Make sure that cables do not come in contact with sharp edges. Use cable ties to fix the cables. Cable ties and tie bases are not included in the scope of delivery. Make sure that cables do not come in contact with sharp edges or moving parts.

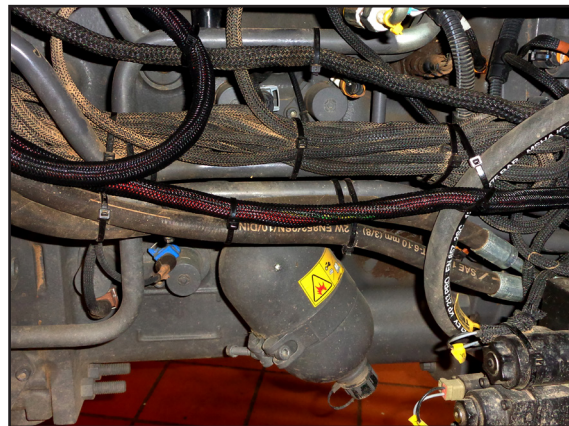

Fig. 62: Fixing and securing the cables

## 5 Commissioning

After connection of all components you can take the *ISO FIT ISOBUS retrofit harness* into operation for the first time. For that purpose, connect a terminal (ISO-VT) to the ISOBUS InCab socket and an isobus-compatible implement to the rear socket and check the functionality.



Risk of injury due to accidents!

Malfunctions and incorrectly connected components can lead to accidents.

If you identify malfunction, stop operation and contact your dealer or the manufacturer.



## 6 User Interface of the TECU (optional)

If you use the optional *ISO FIT – TECU kit (705213)*, you can use the associated user interface to display values from the vehicle or send values to the ISOBUS.

The information below is based on software version 1.1.0.

The screenshots were taken with a Reichhardt Basic terminal. The representation of the TECU application may differ on other VT models.

### 6.1 Overview

Select the TECU application on the ISO-VT.

You will see a graphical overview with various information (see Fig. 63), as described below:

1. Engine Speed [rpm]
2. Rear Hitch In-Work Indication: ON (in working position)/Out of work (in transport position) .
3. Rear Hitch Position [%]
4. Rear PTO Output Shaft Speed [rpm]
5. Rear PTO Engagement [ON/OFF]
6. Ground Based Machine Speed
7. Wheel Based Machine Speed
8. Indication, of whether the ignition is switched on (green key) or switched off (red key).

The units can also be adjusted. Please read Chapter 6.2.

The engine speed (1) is read out via the motor CAN bus. The values 2-7 are transmitted via the signal socket. If the connections are not available, you can use the service menu to set values and send them to the ISOBUS. Please read Chapter 6.3.

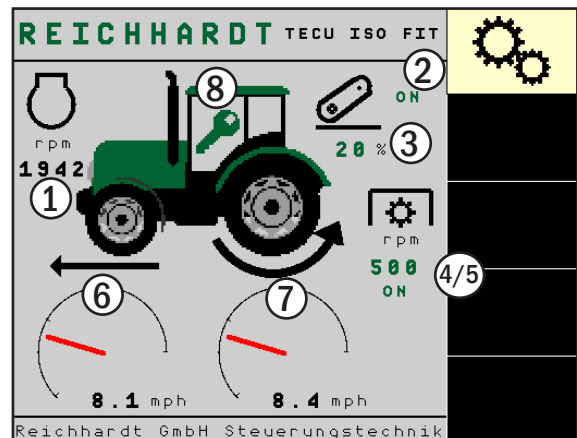

Fig. 63: Overview

## 6.2 Settings

Press the soft key with the gears (see Fig. 64), on the right of the overview, to enter the settings.

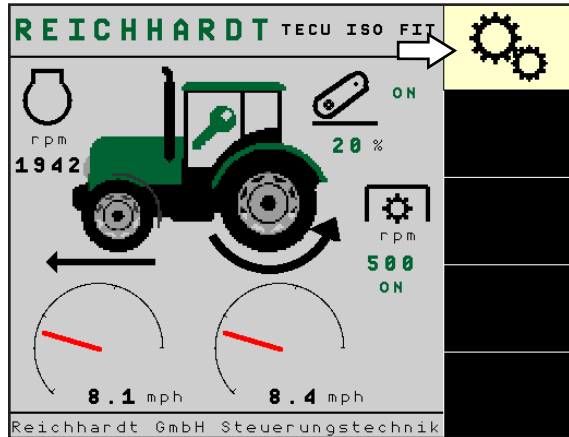

Fig. 64: Enter settings

In the settings, you can specify how long the maximum overrun time of the power supply and electronic power supply should be after switching off the key switch/ignition (Timeout key switch, see Fig. 65 – 1).

Please read Chapter 6.2.1.

In addition, you can optionally make region-specific settings to customize the language and units (Language Information, see Fig. 65 – 2). Please read Chapter 6.2.2.

On the right side of the menu you will find five soft keys that have the following functions:



Press the tractor icon to return to the overview.



Press the tool icon to enter the service menu.



Press the floppy disk icon to save your entries. Please also read Chapter 6.4.

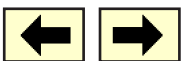

Press the arrow keys to switch between the shown page and the next page of the settings (see Fig. 66).

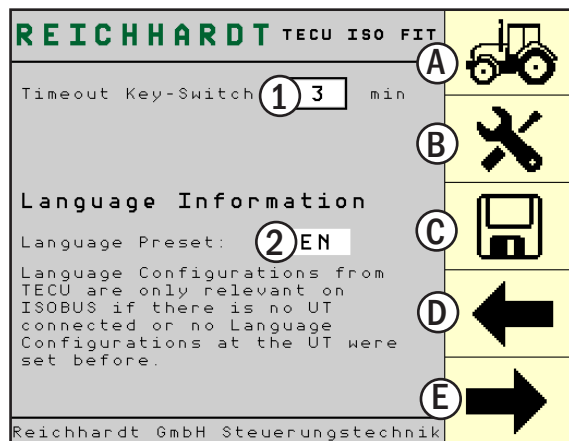

Fig. 65: Settings – Page 1

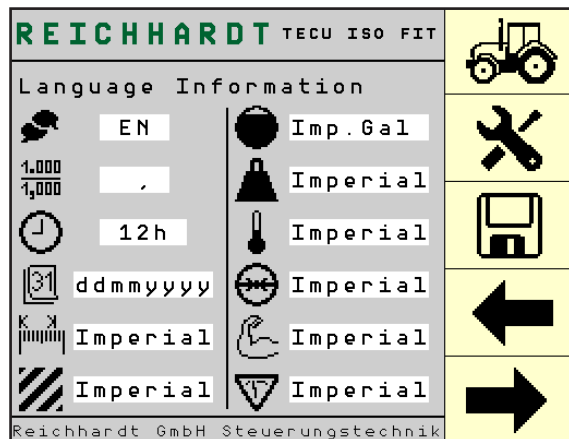

Fig. 66: Settings – Page 2



### 6.2.1 Timeout Key Switch

On the first page of the settings, select the text box after “Timeout key switch” (see Fig. 65 – 1) to set the maximum overrun time of the power supply and electronic power supply after the key switch/ignition is switched off (see Fig. 67).

The value is given in minutes.

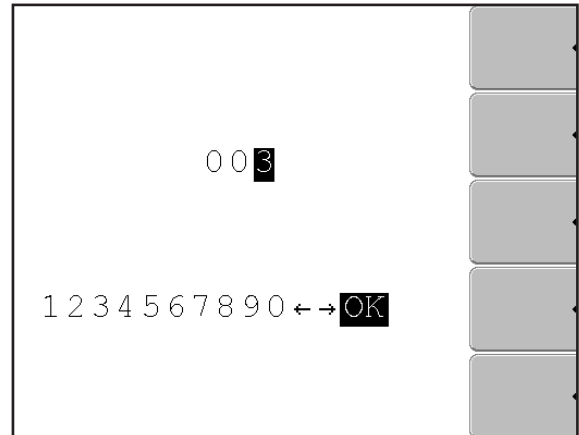

Fig. 67: Timeout of the key switch/ignition

### 6.2.2 Language Information

On the first page of the settings, select the text box after “Language Information” (see Fig. 68 – 2) to make country-specific settings.

**NOTICE**

Country-specific settings are only effective if no country-specific settings have been specified in the VT used. Otherwise, the settings of the VT will be used after each restart.

DE, EN, US: Select a country code to set the units and language used in that country.

Manu: Select “Manu” to manually specify on the second page of the settings what information should be displayed in which units.

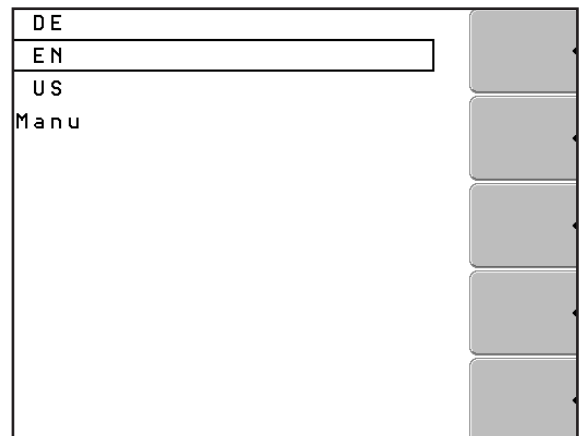













Fig. 68: Selecting language settings

CHAPTER USER INTERFACE OF THE TECU (OPTIONAL)

Use the arrow keys to navigate to the second page of the settings. There you can manually select the settings for the following formats, if you have selected “Manu” (see Fig. 69):

-  Language (DE, EN, US)
-  Decimal mark (. or ,)
-  Time format (12 or 24 hours)
-  Date format (ddmmyyyy, ddyymm, mmyyyy, mmddyy, yyymmdd, yyddmm; d = day, m = month, y = year; see Fig. 70)
-  Unit of length (metric, imperial)
-  Unit of area (metric, imperial)
-  Volume unit (metric, imperial gallons, US gallons)
-  Weight (metric, imperial, US)
-  Temperatur (metric, imperial)
-  Pressure (metric, imperial)
-  Force (metric, imperial)
-  System of units (metric, imperial, US)

If you have selected a setting other than “Manu”, the selection of the individual points is deactivated.

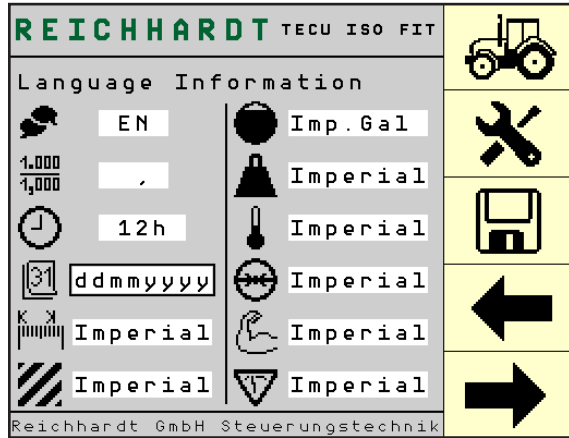

Fig. 69: Manual language information

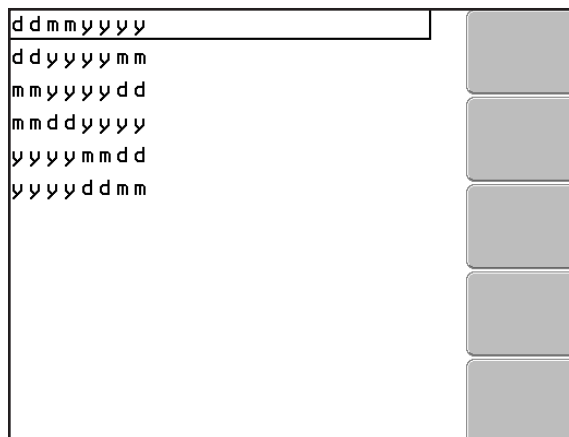

Fig. 70: Example of manual language information settings: Date

## 6.3 Service Menu

In settings, press the tool soft key to open the service menu (see Fig. 71).

The service menu allows you to make adjustments and calibrations of the TECU.

**NOTICE**

Settings in the service menu may overwrite real electrical values that the vehicle provides at the signal socket.

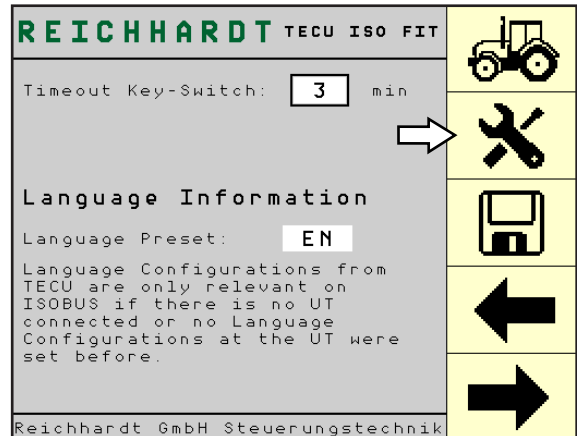

Fig. 71: Selecting service menu

### 6.3.1 Enter Service Code/Overview

To access the service menu, you must enter the service code.





Select the text box and enter the code "1234" (see Fig. 72 - 1).

Press the check mark (see Fig. 72 - 2) to confirm the code and enter the service menu.

Press the X (see Fig. 72 - 3) to return to the settings.

After successfully entering the service code, you will find the first of six pages of the service menu (see Fig. 73).

On the right side of the menu you will find five soft keys with the following functions:

-  Press the tractor to return to the overview.
-  Press the gears to return to the settings.
-  You can save your entries by pressing the floppy disk symbol. Please also read Chapter 6.4.
-   Press the arrow keys to switch between the the individual pages of the service menu.

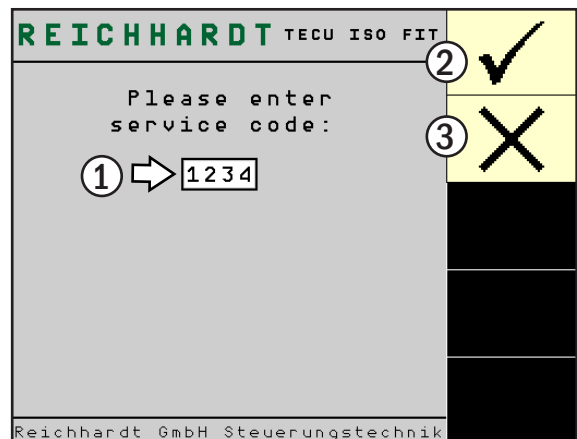

Fig. 72: Entering service code

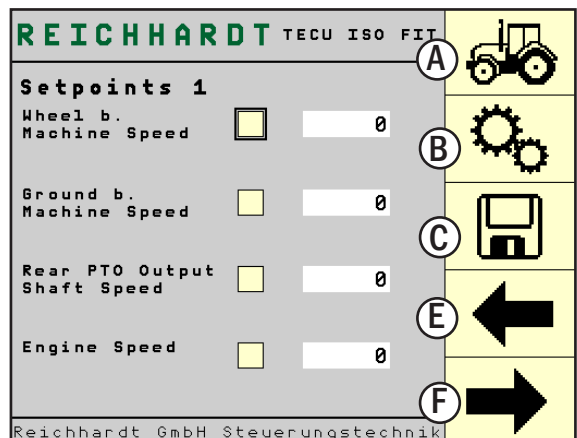

Fig. 73: First page of the service menu

### 6.3.2 Setpoints 1

On the first page of the service menu (see Fig. 74), you can specify four values and send them to the ISOBUS, if these are not available.

Enter the values, activate the check box in front of the respective values and save the information by pressing the floppy disk symbol. The values then are set as default values for the ISOBUS and are displayed in the overview of the TECU application.

If you deactivate the check boxes again, they are no longer set as default values for the ISOBUS.

The value entries are adapted to the representation of the ISOBUS according to ISO 11783-7.

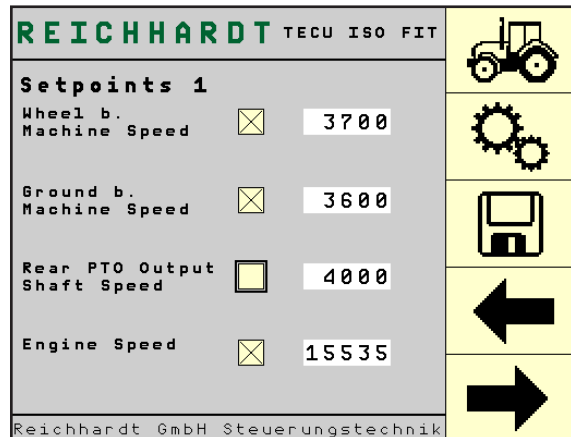

Fig. 74: Setpoints 1

**Wheel Based Machine Speed (WBS):** The value of the speed of a vehicle as calculated from the measured wheel or tail-shaft speed.

The value must be entered in “bit”.

Resolution: 0.001 m/s/bit

Data range: 0 to 64.255 m/s or 0 to 64255 bit

65026 bit = Error indicator

65027 bit = Not available or not installed

**Ground Based Machine Speed (GBS):** Actual distance travelled by a vehicle, based on measurements from a sensor such as radar.

The value must be entered in “bit”.

Resolution: 0.001 m/s/bit

Data range: 0 to 64.255 m/s or 0 to 64255 bit

65026 bit = Error indicator

65027 bit = Not available or not installed

**Rear PTO Output Shaft Speed:** Measured rotational speed (in revolutions) of the rear power take-off (PTO) output shaft.

The value must be entered in “bit”.

Resolution: 0.125 1/min/bit

Data range: 0 to 8031.875 1/min or 0 to 64255 bit

65024 bit = Disabled (Off, passive, etc.)

65025 bit = Enabled (On, active, etc.)

65026 bit = Error indicator

65027 bit = Not available or not installed

Engine Speed: Speed of engine measured in revolutions per minute.  
The value must be entered in "bit".  
Resolution: 0.125 1/min/bit  
Data range: 0 to 8031.875 1/min or 0 to 64255 bit  
65024 bit = Disabled (Off, passive, etc.)  
65025 bit = Enabled (On, active, etc.)  
65026 bit = Error indicator  
65027 bit = Not available or not installed

**Conversion Formula for WBS and GBS:**

Conversion from bit to km/h:  $x \text{ bit} * 0.001 \frac{\frac{\text{m}}{\text{s}}}{\text{bit}} = x \frac{\text{m}}{\text{s}}$        $x \frac{\text{m}}{\text{s}} * \frac{3600 \frac{\text{s}}{\text{h}}}{1000 \frac{\text{m}}{\text{km}}} = x \frac{\text{km}}{\text{h}}$

Conversion from km/h to bit:  $x \frac{\text{km}}{\text{h}} * \frac{1000 \frac{\text{m}}{\text{km}}}{3600 \frac{\text{s}}{\text{h}}} = x \frac{\text{m}}{\text{s}}$        $\frac{x \frac{\text{m}}{\text{s}}}{0.001 \frac{\frac{\text{m}}{\text{s}}}{\text{bit}}} = x \text{ bit}$

**Conversion Formula for PTO and Engine Speed:**

Conversion from bit to 1/min:  $x \text{ bit} * 0.125 \frac{\frac{1}{\text{min}}}{\text{bit}} = x \frac{1}{\text{min}}$

Conversion from 1/min to bit:  $\frac{x \frac{1}{\text{min}}}{0.125 \frac{\frac{1}{\text{min}}}{\text{bit}}} = x \text{ bit}$

**Examples:**

WBS = 3700 bit; to km/h:  $3700 \text{ bit} * 0.001 \frac{\frac{\text{m}}{\text{s}}}{\text{bit}} = 3,7 \frac{\text{m}}{\text{s}}$        $3,7 \frac{\text{m}}{\text{s}} * \frac{3600 \frac{\text{s}}{\text{h}}}{1000 \frac{\text{m}}{\text{km}}} = 13.32 \frac{\text{km}}{\text{h}}$  (8.28 mph)

WBS = 13.2 km/h (8.2 mph); to bit:  $13.3 \frac{\text{km}}{\text{h}} * \frac{1000 \frac{\text{m}}{\text{km}}}{3600 \frac{\text{s}}{\text{h}}} = 3.694 \frac{\text{m}}{\text{s}}$        $\frac{3.694 \frac{\text{m}}{\text{s}}}{0.001 \frac{\frac{\text{m}}{\text{s}}}{\text{bit}}} = 3694 \text{ bit}$

Engine Speed = 15535 bit; to 1/min:  $15535 \text{ bit} * \frac{0.125 \frac{1}{\text{min}}}{\text{bit}} = \frac{1942}{\text{min}}$

Engine Speed = 1942/min; to bit:  $\frac{\frac{1942}{\text{min}}}{\frac{0.125 \frac{1}{\text{min}}}{\text{bit}}} = 15535 \text{ bit}$

### 6.3.3 Setpoints 2

On the second page of the service menu (see Fig. 75), you can specify three values and send them to the ISOBUS, if these are not available.

Enter the values, activate the check box in front of the respective values and save the information by pressing the floppy disk symbol. The values then are set as default values for the ISOBUS and are displayed in the overview of the TECU application.

If you deactivate the check boxes again, they are no longer set as default values for the ISOBUS.

The value entries are adapted to the representation of the ISOBUS according to ISO 11783-7.

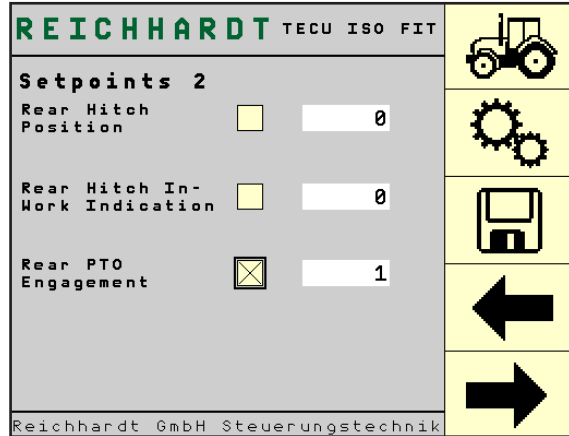

Fig. 75: Setpoints 2

- Rear Hitch Position:** Measured position of the rear three-point hitch.  
 The value must be entered in “bit”.  
 Resolution: 0.4%/bit  
 Data range: 0 to 100% or 0 to 250 bit  
 0% indicates the full down position; 100%, the full up position.
- Rear Hitch In-Work Indication:** Measured signal indicating that the rear hitch is positioned below (in-work) or above (out-of-work) an adjustable switching threshold.  
 The method of determining the switching threshold is not standardized and is to be determined by the manufacturer.  
 There are four different values that indicate different states:  
 0 = Hitch position is out-of-work  
 1 = Hitch position is in-work  
 2 = Error indication  
 3 = Not available
- Rear PTO Engagement:** Measured signal indicating that the rear power take-off (PTO) is engaged or disengaged.  
 There are four different values that indicate different states:  
 0 = PTO disengaged  
 1 = PTO engaged  
 2 = Error indication  
 3 = Not available

**Conversion Formula for Rear Hitch Position:**

- Conversion from bit to %:  $\text{bit} * 0.4\%/\text{bit} = \%$   
 Conversion from % to bit:  $\% / 0.4\%/\text{bit} = \text{bit}$

### 6.3.4 Sensor Signals

On the third page of the service menu you can edit the sensor signals.

#### Activating/Deactivating Pull-up

You can activate a pull-up resistor for the following sensor signals (see Fig. 76 – 1 and 2):

- Wheel Based Machine Speed (value of the speed of a vehicle as calculated from the measured wheel or tail-shaft speed)
- Ground Based Machine Speed (actual distance travelled by a vehicle, based on measurements from a sensor such as radar)
- Rear PTO Output Shaft Speed
- Rear Hitch In-Work Indication

The signal is electrically preset to a defined “high” voltage by a “pull-up” resistor. This is to prevent that an undefined voltage potential leads to different signals at different times. A “pull-up” is mainly needed for low-active sensors.

In the default setting, the pull-up is activated for the first three values, since these are usually necessary for the signal socket.

#### Determining Pulse Rate for WBS (Wheel Based Speed)

Please choose one of the following options.

1. Signal socket with WBS signal according to ISO 11786:

If the built-in signal socket has a WBS signal and it complies with the default value of ISO 11786 (13000 pulses / 100m), you only need to make sure that the check boxes (1) and (2) in Fig. 77 are disabled.

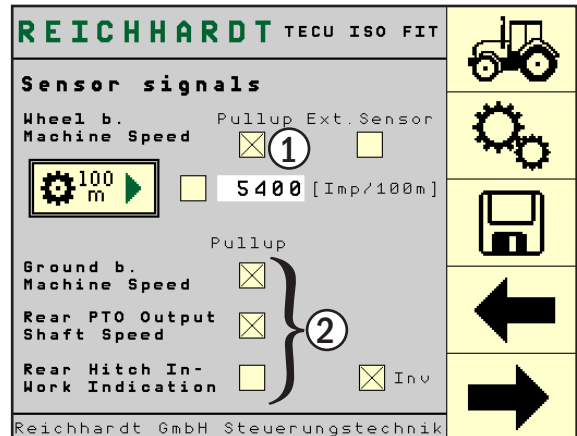

Fig. 76: Sensor signals – Pull-up

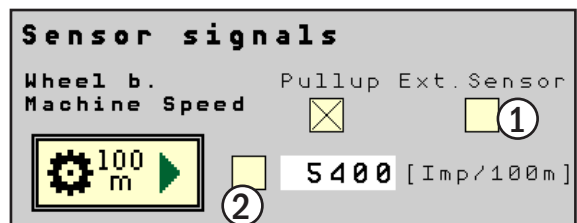

Fig. 77: Sensor signals – WBS via signal socket

2. Signal socket with WBS signal not according to ISO 11786:

Make sure that the check box (1) in Fig. 78 is deactivated to accept the signal socket as a pulse generator.

If the pulse rate of the built-in signal socket does not conform to the default value of ISO 11786 (13000 pulses / 100m), you can manually enter the value in the text box (see Fig. 78 - 3).

If you do not know the value, you can determine it:

- Measure and mark out a distance of 100m.
- Put the vehicle to the starting point.
- Press the 100m soft key (see Fig. 78 - 2).  
 The soft key icon turns red. Move at walking pace towards the end point (see Fig. 79).
- Stop at the end of the 100m and press the 100m soft key again (see Fig. 80).

For both manual value entry and value determination, the valid value range is between 5400 and 66900 Imp/100m.

If you have entered or determined a valid value, the check box in front of the pulse rate is automatically activated (see Fig. 81) to accept this value. Do not select the check box manually.

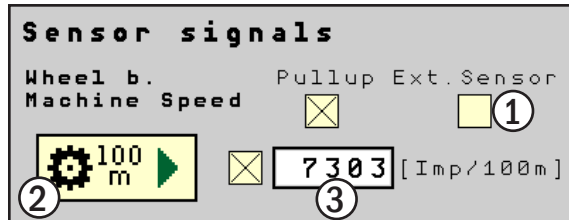

Fig. 78: Sensor signals – Manually enter/determine the pulse rate for WBS of the signal socket

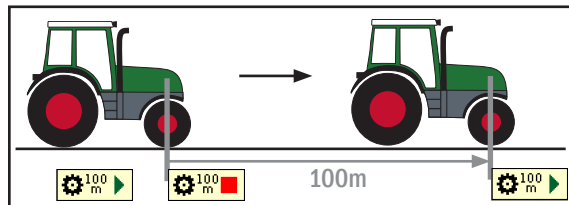

Fig. 79: Drive 100 meters

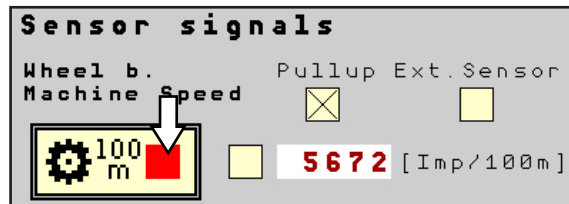

Fig. 80: Determination of the pulse rate is active

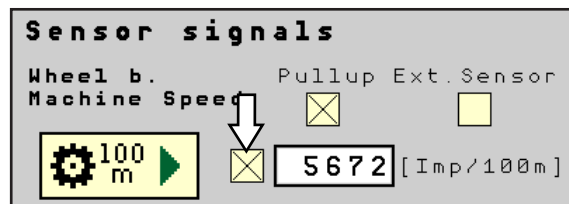

Fig. 81: Pulse rate determined



3. Determining the pulse rate of an external sensor:

The value for the external sensor can also be determined via the software:

- Activate the checkbox (1) in Fig. 82 to accept the external sensor as a pulse generator.
- Measure and mark out a distance of 100m.
- Put the vehicle to the starting point.
- Press the 100m soft key (see Fig. 82 - 2). The soft key icon turns red. Move at walking pace towards the end point (see Fig. 83).
- Stop at the end of the 100m and press the 100m soft key again (see Fig. 84).

The valid value range is between 75 and 2000 Imp/100m. If you have determined a valid value, the check box in front of the pulse rate is automatically activated (see Fig. 85) to accept this value. Do not select the check box manually.

If the value is outside the valid range, try to increase/decrease the number of pulses by changing the measurement setup.

Alternatively you can also activate the check box below "Ext. Sensor" (see Fig. 82 - 1) and specify a value between 5400 and 66900 Imp/100m.

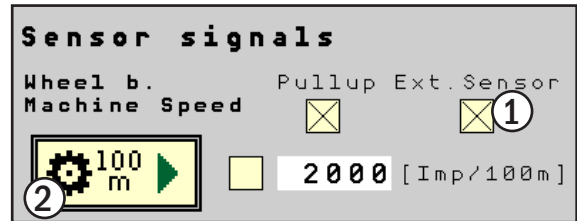

Fig. 82: Sensor signals – Determine pulse rate of an external sensor

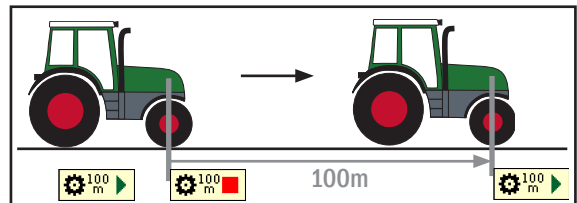

Fig. 83: Drive 100 meters

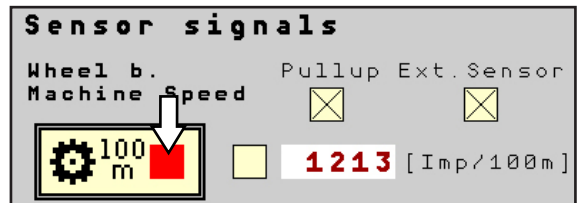

Fig. 84: Determination of the pulse rate is active

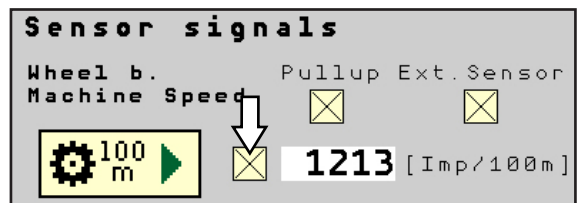

Fig. 85: Pulse rate determined

4. Entering the pulse rate of an external sensor with previous measurement of the wheel circumference:

- Determine the outermost circumference of the wheel on which the external sensor is mounted in meters (see Fig. 86 – 1). This can be realized, for example, by marking on the wheel and measuring the distance traveled during a complete wheel rotation on a firm, level surface.
- Determine the pulses (Imp) which the sensor measures per wheel revolution (Fig. 86 – 2).
- Then calculate Imp/100m using the equation:

$$\text{Imp}/100\text{m} = \frac{100}{\text{wheel circumference [m]}} * \text{pulses per wheel revolution}$$

The valid value range is between 75 and 2000 Imp/100m. If the value is out of range, try increasing/decreasing the number of pulses.

The more pulses per wheel revolution, the more accurate the WBS can be determined.

- Activate the check box (1) in Fig. 87, to use the external sensor as a pulse generator.
- Enter the value in the text box (see Fig. 87 – 3). If you have entered a valid value, the check box in front of the pulse rate is automatically activated (see Fig. 87 – 2) to accept this value. Do not select the check box manually.

If the value is outside the valid range, try to increase/decrease the number of pulses by changing the measurement setup.

Alternatively you can also activate the check box below “Ext. Sensor” (see Fig. 86 – 1) and specify a value between 5400 and 66900 Imp/100m.

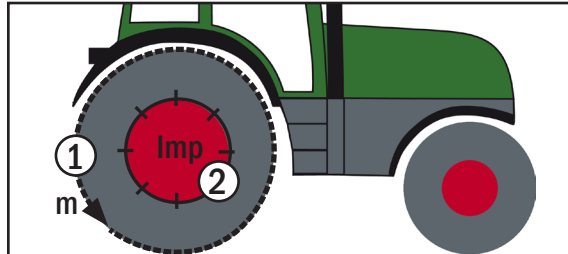

Fig. 86: Determine wheel circumference and pulses per wheel revolution

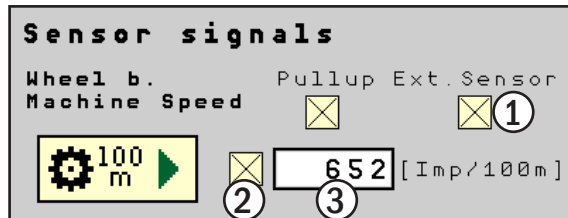

Fig. 87: Sensor signals – Enter pulse rate for external sensor manually

### Invert signal for rear hitch

If you need an inverted signal of the rear linkage, because for example a rear hitch in transport position wrongly transmits the signal “active”, you need to activate the check box next to “Inv” (see Fig. 88).

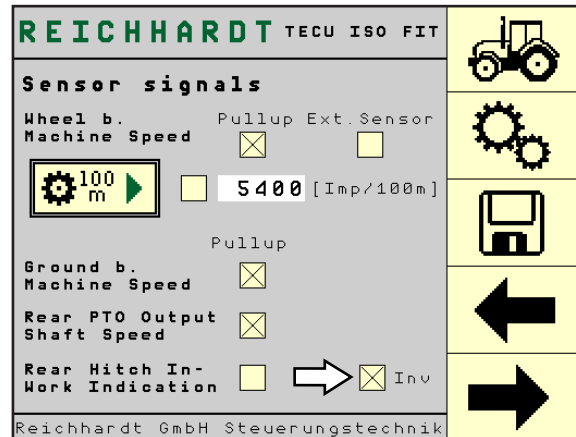

Fig. 88: Sensor signals – Invert signal for rear hitch

### 6.3.5 Rear Hitch In-Work Indication

If there is no sensor signal available for the rear hitch, you can specify a limit value (in %; see Fig. 89 – 2) that serves as the threshold between the working position (active) and the transport position (inactive).

Activate the check box next to “Use hitch position value” (see Fig. 89 – 1) to use the set limit on the ISOBUS. Then save using the floppy disk icon.

If you deactivate the check box again, the value is no longer the default for the ISOBUS.

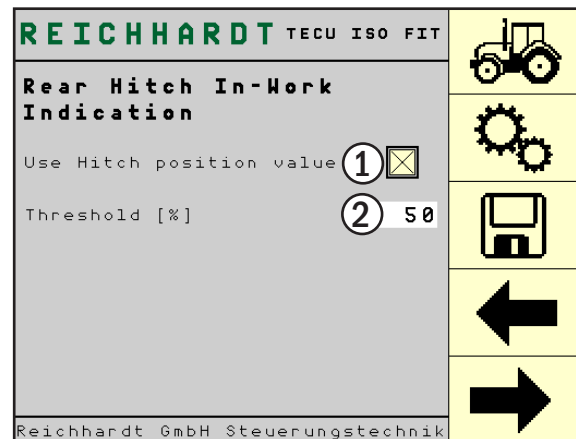

Fig. 89: Rear Hitch In-Work Indication

### 6.3.6 Vehicle Speed

On the fifth page of the service menu, you can set the final value the speedometer displays in the overview (see Fig. 90 – 2 and Fig. 91).

If no signal is available for Wheel Based Machine Speed (WBS) and/or Ground Based Machine Speed (GBS), for example because there is no signal socket, you can use the values of a John Deere StarFire receiver, if any. Activate the check box next to WBS or GBS (see Fig. 90 – 2 and 3).

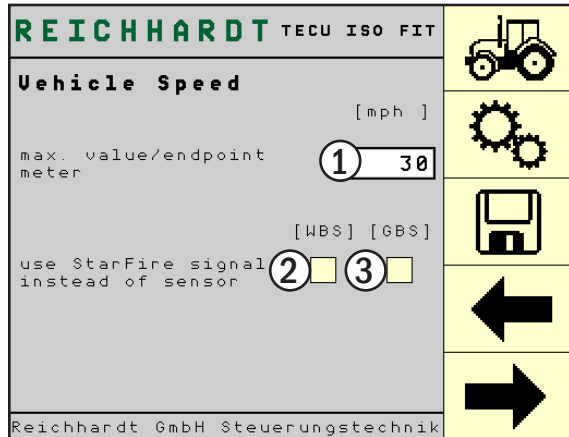

Fig. 90: Vehicle speed

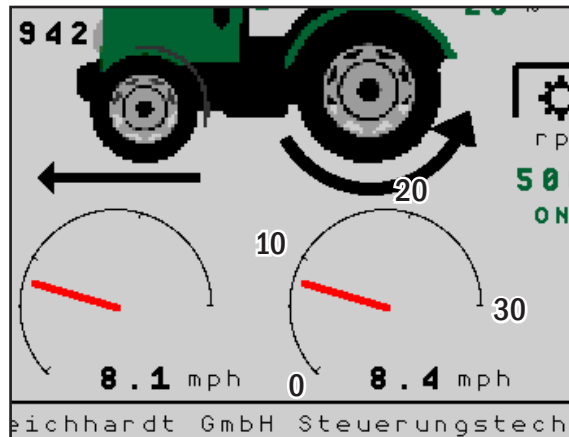

Fig. 91: Speedometer in overview

### 6.3.7 Diagnosis

In the menu item “Diagnosis” in the service menu, the software version and the serial number are displayed (see Fig. 92).

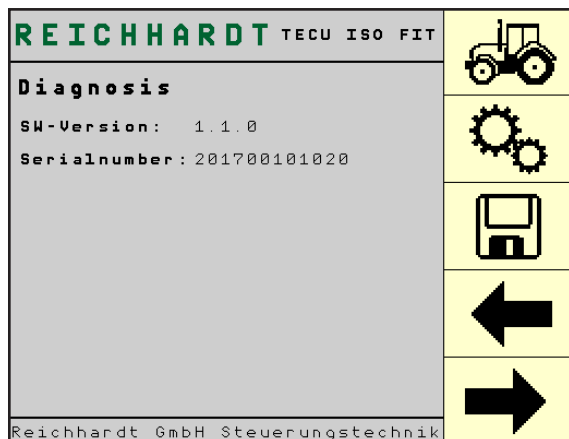

Fig. 92: Diagnosis

## 6.4 Save/Reboot

If you have made a change, you must press the floppy disk symbol (see Fig. 93).

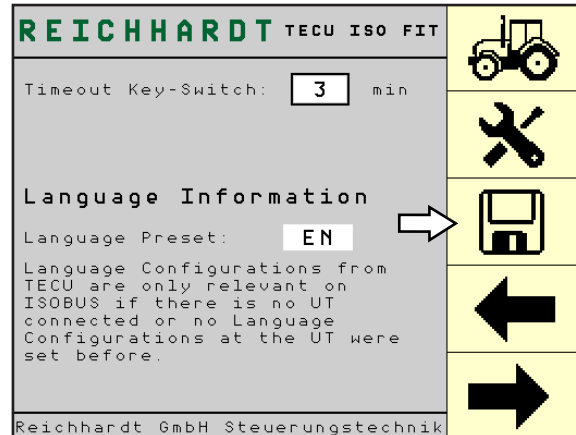

Fig. 93: Save changes

If you have forgotten to save the changes, the TECU application will alert you when you switch to another page (see Fig. 94).

Press the floppy disk icon to save the change.  
 Press the trash can to discard the changes.

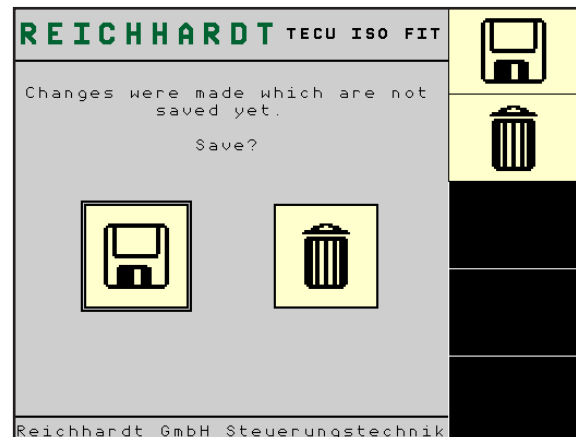

Fig. 94: Prompt to save

To save some entries a reboot of the TECU and/or the terminal is required. This will also be indicated by the TECU application (see Fig. 95).

Press the check mark to initiate the reboot. The power supply and electronic power supply will be disconnected for a short time.

Press the X to return to the previous menu. The changes you have made are not yet active.

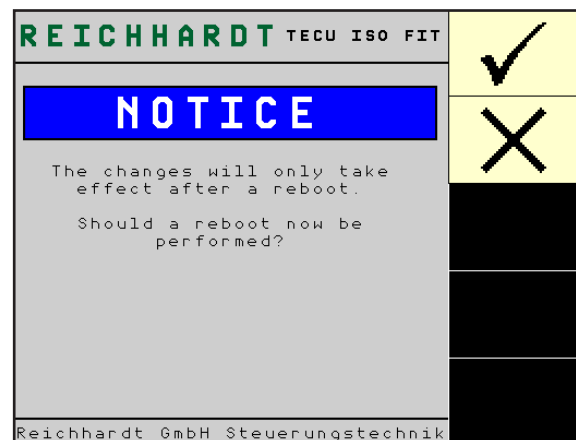

Fig. 95: Prompt to reboot

## 6.5 Malfunction of the System

If there is a malfunction of the system, this will be indicated by a warning on the screen (see Fig. 96).

Put the vehicle and any implements in a safe condition and follow the instructions on the screen.

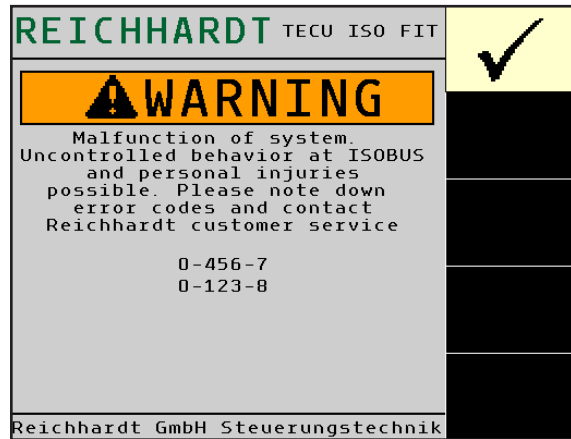

Fig. 96: Warning displays malfunction of the system

## 7 Work and Storage Conditions

The electronic components of the *ISO FIT ISOBUS Retrofit Harness* are intended for use in heavy-duty and harsh environmental conditions in agriculture and similar fields of use.

**NOTICE**

When cleaning the machine, do not directly point the nozzle of the jet cleaner onto the ISO FIT components.

To enhance their service life, you want to make sure that the components are not exposed to unnecessarily high humidity or large temperature variation during storage in winter.

