

TACKLE BLOCK AND SHEAVE ASSEMBLY

WARNING, USE AND MAINTENANCE INFORMATION

WARNING

- A potential hazard exists when lifting or dragging heavy loads with tackle block assemblies.
- Failure to design and use tackle block systems properly may cause a load to slip or fall – the result could be serious injury or death.
- Failure to design lifting system with appropriate sheave assembly material for the intended application may cause premature sheave, bearing or wire rope wear and ultimate failure - the result could be serious injury or death.
- A tackle block system should be rigged by a qualified person as defined by ANSI/ASME B30.26.
- Instruct workers to keep hands and body away from block sheaves and swivels – and away from “pinch points” where rope touches block parts or loads.
- Do not side load tackle blocks.
- See OSHA Rule 1926.1431(g)(1)(i)(A) and 1926.1501(g)(4)(iv)(B) for personnel hoisting by cranes and derricks, and OSHA Directive CPL 2-1.36 — Interim Inspection Procedures During Communication Tower Construction Activities. Only a Crosby or McKissick Hook with a PL latch attached and secured with a bolt, nut and cotter pin (or toggle pin) or a PL-N latch attached and secured with toggle pin; or a Crosby hook with an S-4320 latch attached and secured with cotter pin or bolt, nut and pin; or a Crosby SHUR-LOC® Hook in the locked position may be used for any personnel hoisting. A hook with a Crosby SS-4055 latch attached shall NOT be used for personnel lifting.
- Instruct workers to be alert and to wear proper safety gear in areas where loads are moved or supported with tackle block systems.
- Use only genuine Crosby parts as replacement.
- Read, understand, and follow these instructions to select, use and maintain tackle block systems.
- Do not use a block or ball that does not have a legible capacity tag.

Important:

For maximum safety and efficiency, tackle block and sheave systems must be properly designed, used, and maintained. You must understand the use of tackle block components and sheaves in the system. These instructions provide this knowledge. Read them carefully and completely.

Some parts of these instructions must use technical words and detailed explanations. NOTE: If you do not understand all words, diagrams, and definitions – **DO NOT TRY TO DESIGN OR USE A TACKLE BLOCK OR SHEAVE SYSTEM!** For further assistance, call:

In U.S.A. – Crosby Engineered Products Group at 800-777-1555.

In CANADA – Crosby Canada, Ltd. (905) 451-9261.

In EUROPE – N.V. Crosby Europe 32-15-757125.

As you read instructions, pay particular attention to safety information in bold print.

KEEP INSTRUCTIONS FOR FUTURE USE – DO NOT THROW AWAY!

General Cautions or Warnings

Ratings shown in Crosby Group literature are applicable only to new or “in as new” products.

Working Load Limit ratings indicate the greatest force or load a product can carry under usual environmental conditions. Shock loading and extraordinary conditions must be taken into account when selecting products for use in tackle block systems. Working Load Limit ratings are based on all sheaves of tackle block system being utilized. If all sheaves are not utilized, balance must be maintained, and the Working Load Limit must be reduced proportionally to prevent overloading sheave components. Changes from full sheave reeving arrangement should be only at the recommendation of a qualified person, and incorporate good rigging practices.

In general, the products displayed in Crosby Group literature are used as parts of a system being employed to accomplish a task. Therefore, we can only recommend within the Working Load Limits, or other stated limitations, the use of products for this purpose.

The Working Load Limit or Design (Safety) Factor of each Crosby product may be affected by wear, misuse, overloading, corrosion, deformation, intentional alteration, and other use conditions. Regular inspection must be conducted to determine whether use can be continued at the catalog assigned WLL, a reduced WLL, a reduced Design (Safety) Factor, or withdrawn from service.

Crosby Group products generally are intended for tension or pull. Side loading must be avoided, as it exerts additional force or loading which the product is not designed to accommodate.

Always make sure the hook supports the load. The latch must never support the load.

Welding of load supporting parts or products can be hazardous. Knowledge of materials, heat treatment, and welding procedures are necessary for proper welding. Crosby Group should be consulted for information.

Crane component parts, i.e. the boom, block, overhaul ball, swivel, and wire ropes are metallic and will conduct electricity. Read and understand OSHA standard covering crane and derrick operations (29 CFR 1926.1501 SUBPART N) before operating proximate to power lines.

Definitions

STATIC LOAD – The load resulting from a constantly applied force or load.

WORKING LOAD LIMIT – The maximum mass or force which the product is authorized to support in general service when the pull is applied in-line, unless noted otherwise, with respect to the center line of the product. This term is used interchangeably with the following terms.

1. WLL
2. Rated Load Value
3. SWL
4. Safe Working Load
5. Resultant Safe Working Load

WORKING LOAD – The maximum mass or force which the product is authorized to support in a particular service.

PROOF LOAD – The average force applied in the performance of a proof test; the average force to which a product may be subjected before deformation occurs.

PROOF TEST – A test applied to a product solely to determine non conforming material or manufacturing defects.

ULTIMATE LOAD – The average load or force at which the product fails, or no longer supports the load.

SHOCK LOAD – A force that results from the rapid application of a force (such as impacting and/or jerking) or rapid movement of a static load. A shock load significantly adds to the static load.

DESIGN (SAFETY) FACTOR – An industry term denoting a product's theoretical reserve capability; usually computed by dividing the catalog Ultimate Load by the Working Load Limit. Generally expressed for blocks as a ratio of 4 to 1.

TACKLE BLOCK – An assembly consisting of a sheave(s), side plates, and generally an end fitting (hook, shackle, etc.) that is used for lifting, lowering, or applying tension.

SHEAVE / SHEAVE BEARING ASSEMBLY – Purchased by O.E.M. or end user to be used in their block or lifting system design.

Fitting Maintenance

Fittings, including hooks, overhaul balls, shackles, links, etc., may become worn and disfigured with use, corrosion, and abuse resulting in nicks, gouges, worn threads and bearings, sharp corners which may produce additional stress conditions and reduce system load capacity.

Grinding is the recommended procedure to restore smooth surfaces. The maximum allowance for reduction of a product's original dimension due to wear or repair before removal from service is:

1. Any single direction - No more than 10% of original dimension;
2. Two directions - No more than 5% of each dimension.

For detailed instructions on specific product, see the application and warning information for that product. Any greater reduction may necessitate a reduced Working Load Limit.

Any crack or deformation in a fitting is sufficient cause to withdraw the product from service.

Selection Guide

Some of the blocks shown in Crosby Group literature are named for their intended use and selection is routine. A few examples include the "Double Rig Trawl Block" used in the fishing industry, the "Well Loggers Block" used in the oil drilling industry, and the "Cargo Hoisting Block" used in the freighter boat industry and "Derrick and Tower Block" used for hoisting personnel. Others are more generally classified and have a variety of uses. They include snatch blocks, regular wood blocks, standard steel blocks, etc. For example, snatch blocks allow the line to be attached by opening up the block instead of threading the line through the block. This feature eliminates the use of rope guards and allows various line entrance and exit angles to change direction of the load. These angles determine the load on the block and/or the block fitting. (See "Loads on Blocks.") Snatch blocks are intended for infrequent and intermittent use with slow line speeds.

A tackle block sheave assembly is one element of a system used to lift, change direction or drag a load. There are other elements in the system including the prime mover (hoist, winch, hand), supporting structure, power available, etc. All of these elements can influence the type of tackle block or sheave required. When selecting a block or sheave for the system in your specific application, you should consider the other elements as well as the features of the blocks and sheaves shown in Crosby Group literature.

To select a tackle block or sheave to fit your requirements, consider the following points:

1. Are there regulations which could affect your choice of blocks or sheaves, such as federal or state OSHA, elevator safety, mine safety, maritime, insurance, etc.?
2. What is the weight of the load, including any dynamics of impacts that add to load value? You must know this to determine the minimum required Working Load Limit value of the block or load on sheave.
3. How many parts of line are required? This can be determined given the load to be lifted and the line pull you have available. As an alternative, you could calculate the line pull required with a given number of parts of line and a given load weight. (See "How to Figure Line Parts").
4. What is the size of line to be used? Multiply the available line pull by the desired safety factor for wire rope to determine the minimum catalog wire rope breaking strength; consult a wire rope catalog for the corresponding grade and diameter of wire rope to match. You should also consider fatigue factors that affect wire rope life. (See "Sheave Size & Wire Rope Strength").
5. What is the speed of the line? This will help you determine the type of sheave bearing necessary. There are several choices of bearings suitable for different applications, including:
 6. **Common (Plain) Bore** for very slow line speeds and very infrequent use (high bearing friction).
 7. **Self Lubricating Bronze Bushings** for slow line speeds and infrequent use (moderate bearing friction).
 8. **Bronze Bushing** with pressure lubrication for slow line speeds and more frequent use at greater loads (moderate bearing friction).
 9. **Anti-friction Bearings** for faster line speeds and more frequent use at greater loads (minimum bearing friction).
10. What type of fitting is required for your application? The selection may depend on whether the block will be traveling or stationary. Your choices include single or multiple hooks with or without throat latches and shackles, which are the most secured load attachment. You should also decide whether the fitting should be fixed, swivel or swivel with lock. If it is a swivel fitting, then selection of a thrust bearing may be necessary. There are plain fittings with no bearings for positioning at no load, bronze bushed fittings for infrequent and moderate load swiveling, and anti-friction bearing equipped fittings for frequent load swiveling.
11. How will the block be reeved and does it require a dead end becket? (See "The Reeving of Tackle Blocks").
12. If the block is to be a traveling block, what weight is required to overhaul the line? (See "How to Determine Overhaul Weights").
13. What is the fleet angle of the wire line? Line entrance and exit angles should be no more than 1-1/2 degrees.
14. How will the block or sheave be maintained? Do conditions in your application require special maintenance considerations? (See "Tackle Block and Sheave Maintenance," and "Fitting Maintenance").
15. Reference current edition of "Wire Rope Users Manual" for additional sheave design and maintenance information.

Tackle Block and Sheave Maintenance

Tackle Blocks and Sheaves must be regularly inspected, lubricated, and maintained for peak efficiency and extended usefulness. Their proper use and maintenance is equal in importance to other mechanical equipment. The frequency of inspection and lubrication is dependent upon frequency and periods of use, environmental conditions, and the user's good judgment.

Inspection: As a minimum, the following points should be considered:

1. Wear on pins or axles, rope grooves, side plates, bushing or bearings, cases, trunnions, hook shanks, and fittings (See Fitting Maintenance) Excessive wear may be a cause to replace parts or remove block or sheave from service.
2. Deformation in side plates, pins and axles, fitting attachment points, trunnions, etc. Deformation can be caused by abusive service and / or overload and may be a cause to remove block or sheave from service.
3. Misalignment or wobble in sheaves.
4. Security of nuts, bolts, and other locking methods, especially after reassembly following a tear down inspection. Original securing method should be used; e.g., staking, set screw, cotter pin, cap screw.
5. Pins retained by snap rings should be checked for missing or loose rings.
6. Sheave pin nuts should be checked for proper positioning. Pins for tapered roller bearings should be tightened to remove all end play during sheave rotation. Pins for bronze bushings and straight roller bearings should have a running clearance of .031 inch per sheave of end play and should be adjusted accordingly.
7. Hook or shackle to swivel case clearance is set at .031 to .062 at the factory. Increased clearance can result from component wear. Clearance exceeding .12 to .18 should necessitate disassembly and further inspection.
8. Deformation or corrosion of hook and nut threads. Your block's hook may be fitted with the Crosby/McKissick Patented Split Nut. Refer to the Split Nut section for proper Removal, Inspection and installation procedures.
9. Loss of material due to corrosion or wear on external area of welded hook and nut may indicate thread corrosion or damage. If these conditions exist, remove from service or perform load test.
10. Surface condition and deformation of hook (See Fitting Maintenance and ANSI B30.10.)
11. Welded side plates for weld corrosion or weld cracking.
12. Hook latch for deformation, proper fit and operation.
13. Remove from service any bushings with cracks on inside diameter or bushing end. Bushings that are cracked and/or extended beyond sheave hub are indications of bushing overload.

LUBRICATION : The frequency of lubrication depends upon frequency and period of product use as well as environmental conditions, which are contingent upon the user's good judgment. Assuming normal product use, the following schedule is suggested when using lithium-base grease of a medium consistency.

SHEAVE BEARINGS

Tapered Roller Bearings – Every 40 hours of continuous operation or every 30 days of intermittent operation.

Roller Bearings – Every 24 hours of continuous operation or every 14 days of intermittent operation.

Bronze Bushings – (Not Self Lubricated) – Every 8 hours of continuous operation or every 14 days of intermittent operation.

Self Lubricating Bronze Bushing – are for slow line speeds and infrequent use (moderate bearing friction). Frequent inspection is required to determine the condition of bushing.

HOOK BEARINGS

Anti Friction – Every 14 days for frequent swiveling; every 45 days for infrequent swiveling.

Bronze Thrust Bushing or No Bearing Every 16 hours for frequent swiveling; every 21 days for infrequent swiveling.

Tackle Block Maintenance also depends upon proper block selection (see "Loads on Blocks"), proper reeving (see "The Reeving of Tackle Blocks"), consideration of shock loads, side loading, and other adverse conditions.

Sheave Bearing Application Information

Sheaves in a system of blocks rotate at different rates of speed, and have different loads. When raising and lowering, the line tension is not equal throughout the system. Refer to Page 49 "How to Figure Line Parts" for assistance in determining lead line loads used for bushing or bearing selection.

BRONZE BUSHINGS

Bronze Bushings are used primarily for sheave applications using slow line speed, moderate load, and moderate use. The performance capability of a bearing is related to the bearing pressure and the bearing surface velocity by a relationship known as true PV (Maximum Pressure - Velocity Factor). The material properties of the Bronze Bushings furnished as standard in Crosby catalog sheaves are:

(BP) Maximum Bearing Pressure :4500 PSI

(BV) Maximum Velocity at Bearing :1200 FPM

(PV) Maximum Pressure Velocity Factor: 55000

(It should be noted that due to material property relations, the maximum BP times the maximum BV is NOT equal to the maximum PV.) Formula for Calculating Bearing Pressure:

Formula for Calculating Bearing Pressure:

$$BP = \frac{\text{Line Pull} \times \text{Angle Factor}}{\text{Shaft Size} \times \text{Hub Width}}$$

Note: Angle Factor Multipliers listed on page 3.

Formula for Calculating Bearing Velocity:

$$BV = \frac{PV}{BP}$$

Formula for Calculating Line Speed:

$$\text{Line Speed} = \frac{BV (\text{Tread Diameter} + \text{Rope Diameter})}{\text{Shaft Diameter}}$$

Calculations can be made to find the maximum allowable line speed for a given total sheave load. If the required line speed is greater than the maximum allowable line speed calculated, then increase the shaft size and/or the hub width and recalculate. Continue the process until the maximum allowable line speed is equal to or exceeds the required line speed.

Example

Using a 14 in. sheave (Stock # 917191; refer to wire rope sheave section of General Catalog for dimensions) with a 4,600 lbs. line pull and an 80° angle between lines determine maximum allowable line speed.

$$BP = (4,600 \text{ lbs.} \times 1.53) \div (1.50 \times 1.62) = 2,896 \text{ PSI}$$

(line pull) (angle factor) (Shaft Size) (Hub Width)

$$BV = 55,000 \div 2,896 = 19 \text{ FPM Allowable}$$

(PV Factor) (BP)

Line Speed =
 $[19 \times (11.75 + .75)] \div 1.50 = 158.3 \text{ FPM ALLOWABLE}$
 (BV) (Tread Dia. + Rope Size) ÷ (Shaft Dia.)

If the application required a line speed equal to 200 FPM, then another calculation would be necessary. Trying another 14 in. sheave (stock # 4104828) under the same loading conditions, the results are as follows:

BP = (4,600 lbs. x 1.53) ÷ (2.75 x 2.31) = 1,108 PSI

BV = 55,000 ÷ 1,108 = 50 FPM

Line Speed =
 $[50 \times (11.75 + .75)] \div 2.75 = 227.3 \text{ FPM ALLOWABLE}$

COMMON (PLAIN) BORE –

Very slow line speed, very infrequent use, low load.

ROLLER BEARING –

Faster line speeds, more frequent use, greater load. Refer to manufacturer's rating. Reference appropriate bearing manufacturer's catalog for proper bearing selection procedure.

Loads on Blocks

The Working Load Limit (WLL) for Crosby Group blocks indicates the maximum load that should be exerted on the block and its connecting fitting.

This total load value may be different from the weight being lifted or pulled by a hoisting or hauling system. It is necessary to determine the total load being imposed on each block in the system to properly determine the rated capacity block to be used.

A single sheave block used to change load line direction can be subjected to total loads greatly different from the weight being lifted or pulled. The total load value varies with the angle between the incoming and departing lines to the block.

The following chart indicates the factor to be multiplied by the line pull to obtain the total load on the block.

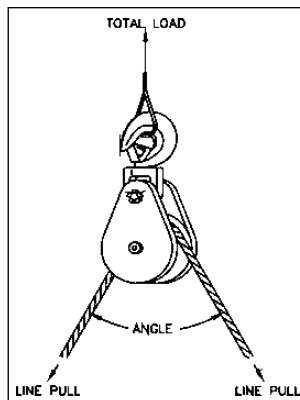

Angle Factor Multipliers			
Angle	Factor	Angle	Factor
0°	2.00	100°	1.29
10°	1.99	110°	1.15
20°	1.97	120°	1.00
30°	1.93	130°	.84
40°	1.87	135°	.76
45°	1.84	140°	.68
50°	1.81	150°	.52
60°	1.73	160°	.35
70°	1.64	170°	.17
80°	1.53	180°	.00
90°	1.41	—	—

Example A

(Calculations for determining total load value on single line system.)

A gin pole truck lifting 1,000 lbs.

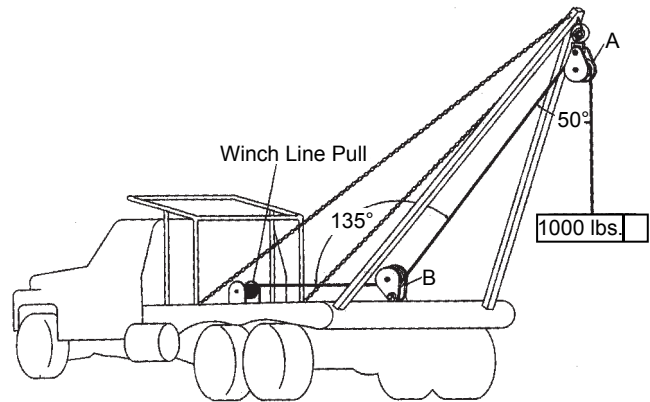

There is no mechanical advantage to a single part load line system, so winch line pull is equal to 1,000 lbs. or the weight being lifted.

To determine total load on snatch block A:

A = 1,000 lbs. x 1.81 = 1,810 lbs.
 (line pull) (factor 50° angle)

To determine total load on toggle block B:

B = 1,000 lbs. x .76 = 760 lbs.
 (line pull) (factor 135° angle)

Example B

(Calculation for determining total load value for mechanical advantage system.)

Hoisting system lifting 1,000 lb. using a traveling block.
 The mechanical advantage of traveling block C is 2.00 because two (2) parts of load line support the 1,000 lbs weight. (Note that this example is simplified or determination of resultant load on blocks. Lead line pull will be greater than shown due to efficiency losses.) (To determine single line pull for various bearing efficiency see "How to Figure Line Parts".)
 To Determine Line Pull:
Line Pull = 1,000 lbs. ÷ 2.00 = 500 lbs.

To determine total load on traveling block C:
C = 500 lbs. x 2.0 = 1,000 lbs.
 (line pull)(Factor 0° angle)

To determine total load on stationary block D:
D = 500 lbs. x 1.87 + 500 lbs. = 1,435 lbs.
 (line pull) (dead-end load)
 (Factor 40° angle)

To determine total load on block E:
E = 500 lbs. x .84 = 420 lbs.
 (line pull) (Factor 130° angle)

To determine total load on block F:
F = 500 lbs. x 1.41 = 705 lbs.
 (line pull) (Factor 90° angle)

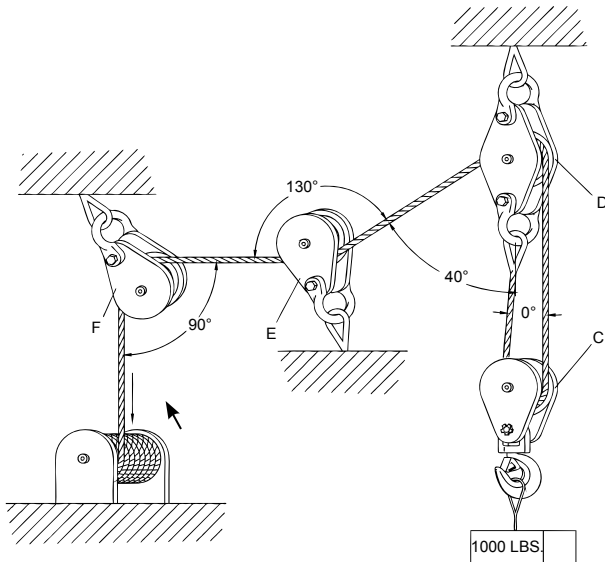

The Reeving of Tackle Blocks

In reeving of tackle blocks, there are many methods. The method discussed below is referred to as "Right Angle" reeving. Please consult your rigging manual for other methods of reeving.

RIGHT ANGLE REEIVING

In reeving of tackle blocks, there are many methods. The method discussed below is referred to as "Right Angle" reeving. Please consult your rigging manual for other methods of reeving.

RIGHT ANGLE REEIVING

In reeving a pair of tackle blocks, one of which has more than two sheaves, the hoisting rope should lead from one of the center sheaves of the upper block to prevent toppling and avoid injury to the rope. The two blocks should be placed so that the sheaves in the upper block are at right angles to those in the lower one, as shown in the following illustrations.

Start reeving with the becket or dead end of the rope. **Use a shackle block as the upper one of a pair and a hook block as the lower one as seen below.** Sheaves in a set of blocks revolve at different rates of speed. Those nearest the lead line revolve at the highest rate of speed and wear out more rapidly. All sheaves should be kept well lubricated when in operation to reduce friction and wear.

Reeving Diagram

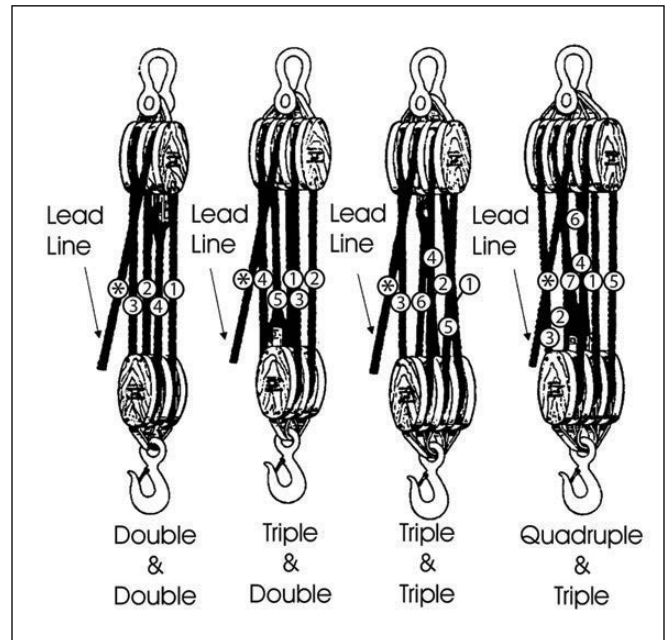

CAUTION

- Exercise care when block is standing in vertical position, as the potential for tipping exists. Potential causes of tipping are unstable work area, boom movement and the reeving process.
- If work area is unstable, lay block flat on side plate.

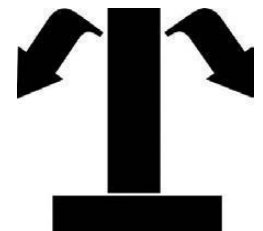

Sheave Size & Wire Rope Strength

Strength Efficiency

Bending wire rope reduces its strength. To account for the effect of bend radius on wire rope strength when selecting a sheave, use the table below:

Ratio A	Strength Efficiency Compared to Catalog Strength in %
40	95
30	93
20	91
15	89
10	86
8	83
6	79
4	75
2	65
1	50

$$\text{Ratio A} = \frac{\text{Sheave Diameter}}{\text{Rope Diameter}}$$

Example

To determine the strength efficiency of 1/2" diameter wire rope using a 10" diameter sheave:

$$\text{Ratio A} = \frac{10'' \text{ (sheave diameter)}}{1/2'' \text{ (wire rope diameter)}} = 20$$

Refer to ratio A of 20 in the table then check the column under the heading "Strength Efficiency Compared to Catalog Strength in %"...91% strength efficiency as compared to the catalog strength of wire rope.

Fatigue Life

Repeated bending and straightening of wire rope causes a cyclic change of stress called "fatiguing." Bend radius affects wire rope fatigue life. A comparison of the relative effect of sheave diameter on wire rope fatigue life can be determined as shown below:

Ratio B	Relative Fatigue Bending Life
30	10.0
25	6.6
20	3.8
18	2.9
16	2.1
14	1.5
12	1.1

$$\text{Ratio B} = \frac{\text{Sheave Diameter}}{\text{Rope Diameter}}$$

$$\text{Relative Fatigue Bending Life} = \frac{\text{Relative Fatigue Bending Life Sheave \#1}}{\text{Relative Fatigue Bending Life (Sheave \#2)}}$$

Example

To determine the extension of fatigue life for a 3/4" wire rope using a 22.5" diameter sheave versus a 12" diameter sheave:

$$\text{Ratio B} = \frac{22.5'' \text{ (sheave diameter)}}{3/4'' \text{ (wire rope diameter)}} = 30$$

$$\text{Ratio B} = \frac{12'' \text{ (sheave diameter)}}{3/4'' \text{ (wire rope diameter)}} = 16$$

The relative fatigue bending life for a ratio B of 16 is 2.1 (see above Table) and ratio B of 30 is 10.

$$\text{Relative Fatigue Bending Life} = \frac{10}{2.1} = 4.7$$

Therefore, we expect extension of fatigue life using a 22.5" diameter sheave to be 4.7 times greater than that of a 12" diameter sheave.

How to Determine Overhauling Weights

To determine the weight of the block or overhaul ball that is required to free fall the block, the following information is needed: size of wire rope, number of line parts, type of sheave bearing, length of crane boom, and drum friction (use 25kg, unless other information is available).

Wire Rope Size (in.)	Factor A – Wire Rope Weight lbs. per ft., 6 x 19 IWRC
3/8	.26
7/16	.35
1/2	.46
9/16	.59
5/8	.72
3/4	1.04
7/8	1.42
1	1.85
1-1/8	2.34
1-1/4	2.89

Number of Line Parts	Factor B – Overhaul Factors	
	Roller Bearing Sheaves	Bronze Bushed Sheaves
1	1.03	1.05
2	2.07	2.15
3	3.15	3.28
4	4.25	4.48
5	5.38	5.72
6	6.54	7.03
7	7.73	8.39
8	8.94	9.80
9	10.20	11.30
10	11.50	12.80

The Formula is:

Required Block Weight = [(Boom Length x Factor A) + Drum Friction] x Factor B

Example:

To determine the required block or overhaul weight using 5 parts of 7/8" diameter wire rope, a 50 ft. boom and roller bearing sheaves:

Required Block Weight =
$$\frac{[(50 \text{ ft.} \times 1.42) + 50 \text{ lbs.}] \times 5.38}{\text{(Factor A)} \quad \text{(Drum Friction)} \quad \text{(Factor B)}} = 651 \text{ lbs.}$$

How to Figure Line Parts

Sheaves in a system of blocks rotate at different rates of speed, and have different loads. When raising and lowering, the line tension is not equal throughout the system. To help figure the number of parts of line to be used for a given load, or the line pull required for a given load, (for example, use Reeving Diagram on page 379. Only numbered lines shall be used in the calculation). The following ratio table is provided with examples of how to use it. The ratios are applicable for blocks as shown on page 379 and also independent sheave systems that line is reeved through.

Ratio A Bronze Bushed Sheaves	Ratio B Anti-Friction Bearing Sheaves	Number of Line Parts
.96	.98	1
1.87	1.94	2
2.75	2.88	3
3.59	3.81	4
4.39	4.71	5
5.16	5.60	6
5.90	6.47	7
6.60	7.32	8
7.27	8.16	9
7.91	8.98	10
8.52	9.79	11
9.11	10.60	12
9.68	11.40	13
10.20	12.10	14
10.70	12.90	15
11.20	13.60	16
11.70	14.30	17
12.20	15.00	18
12.60	15.70	19
13.00	16.40	20

Ratio A or B = $\frac{\text{Total Load to be Lifted}}{\text{Single Line Pull (lbs.)}}$

After calculating Ratio A or B, consult table to determine number of parts of line.

Examples:

To find the number of parts of line needed when weight of load and single line pull are known, and using Bronze Bushed Sheaves.

Ratio A = $\frac{72,180 \text{ lbs. (load to be lifted)}}{8000 \text{ lbs. (single line pull)}} = 9.02$ (Ratio A)

In table above refer to ratio 9.02 or next highest number, then check column under heading "Number of Line Parts" = 12 parts of line to be used for this load.

To find the single line pull needed when weight of load and number of parts of line are known, and using Anti-Friction Bearing Sheaves.

Single Line Pull = $\frac{68,000 \text{ lbs. (load to be lifted)}}{7.32 \text{ (Ratio B of 8part line)}} = 9,290 \text{ lbs.}$

9,290 lbs. single line pull required to lift this load on 8 parts of line.

To find the lift capacity when the parts of line and single line pull are known, and using anti-friction bearing sheaves.

10,000 lbs. (Single line pull)
x 4.71 (Ratio B of 5 parts of line)
= 47,100 lbs. (Lift Capacity)

10,000 lbs. single line pull with 5 parts of line will accommodate 47,100 lbs. lift capacity.

Repairs

For repair of blocks, contact the following numbers for return material authorization.

IN U.S.A. – Crosby Engineered Products Group at (800) 777-1555

IN CANADA – Crosby Canada at (905) 451-9261

IN EUROPE – N.V. Crosby Europe at (+32) (0)15 75 71 25

Your block, after receipt by Crosby, will be inspected and a free estimate of repair charges will be provided. Authorization for repairs from block owners must be given to Crosby before repairs are made. Transportation charges, both to and from factory, are to be paid by the block owner.

Additional Information

For information concerning parts, special application, or situations requiring other features, contact:

U.S.A.

The Crosby Group LLC
P.O. Box 3128
Tulsa, OK 74101-3128
(918) 834-4611
FAX (918) 832-0940
www.thecrosbygroup.com
crosbygroup@thecrosbygroup.com

CANADA

Crosby Canada
145 Heart Lake Road
Brampton, Ontario, Canada L6W 3K3
(905) 451-9261
FAX (877)260-5106
www.thecrosbygroup.com
sales@crosby.ca

EUROPE

Belgium
Industriepark Zone B n°26
2220 Heist-op-den-Berg.
P: (+32) (0)15 75 71 25
F: (+32) (0)15 75 37 64
www.thecrosbygroup.com
sales@crosbyeurope.com

How to Find Your Nearest Crosby Distributor

To locate your nearest Crosby Distributor, call:

IN U.S.A. – Crosby Engineered Products Group at (800) 777-1500

IN CANADA – Crosby Canada at (905) 451-9261

IN EUROPE – N.V. Crosby Europe at (+32) (0)15 75 71 25

McKISSICK® HOIST HOOK

WARNINGS AND APPLICATION INSTRUCTIONS



S-320 Series

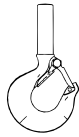

S-319 Series



S-322 Series
Positioning
Only



S-3322B Series

⚠ WARNING

- Loads may disengage from hook if proper procedures are not followed.
- A falling load may cause serious injury or death.
- See OSHA Rule 1926.1431(g)(1)(i)(A) and 1926.1501(g)(4)(iv)(B) for personnel hoisting by cranes and derricks, and OSHA Directive CPL 2-1.36 - Interim Inspection Procedures During Communication Tower Construction Activities. A Crosby 319, 320 or 322 hook with a PL latch attached and secured with a bolt, nut and cotter pin (or toggle pin) may be used for lifting personnel. A Crosby 319N, 320N or 322N hook with an S-4320 latch attached and secured with cotter pin or bolt, nut and pin; or a PL-N latch attached and secured with toggle pin may be used for lifting personnel. A hook with a Crosby SS-4055 latch attached shall NOT be used for personnel lifting.
- See OSHA Directive CPL 2-1.36 - Crosby does not recommend the placement of lanyards directly into the positive locking Crosby hook when hoisting personnel. Crosby requires that all suspension systems (vertical lifelines / lanyard) shall be gathered at the positive locked load hook by use of a master link, or a bolt-type shackle secured with cotter pin.
- Threads or Split-Nut may corrode and/or strip and drop the load.
- Remove securement nut to inspect or to replace S-322 and S-3319 bearing washers (2).
- Hook must always support the load. The load must never be supported by the latch.
- Never apply more force than the hook's assigned Working Load Limit (WLL) rating.
- Read and understand these instructions before using hook.

QUIC-CHECK® Hoist hooks incorporate markings forged into the product which address two (2) QUIC-CHECK® features:

Deformation Indicators - Two strategically placed marks, one just below the shank or eye and the other on the hook tip, which allows for a QUIC-CHECK® measurement to determine if the throat opening has changed, thus indicating abuse or overload.

To check, use a measuring device (i.e., tape measure) to measure the distance between the marks. The marks should align to either an inch or half-inch increment on the measuring device. If the measurement does not meet criteria, the hook should be inspected further for possible damage.

Angle Indicators - Indicates the maximum included angle which is allowed between two (2) sling legs in the hook. These indicators also provide the opportunity to approximate other included angles between two sling legs.



IMPORTANT SAFETY INFORMATION – READ AND FOLLOW

- A visual periodic inspection for cracks, nicks, wear, gouges and deformation as part of a comprehensive documented inspection program, should be conducted by trained personnel in compliance with the schedule in ANSI B30.10.
- For hooks used in frequent load cycles or pulsating loads, the hook and threads should be periodically inspected by Magnetic Particle or Dye Penetrant. (Note: Some disassembly may be required.)
- Never use a hook whose throat opening has been increased, or whose tip has been bent more than 10 degrees out of plane from the hook body, or is in any other way distorted or bent. **Note: A latch will**

- **not work properly on a hook with a bent or worn tip.**
- Never use a hook that is worn beyond the limits shown in Figure 1.
- Remove from service any hook with a crack, nick, or gouge. Hooks with a nick or gouge shall be repaired by grinding lengthwise, following the contour of the hook, provided that the reduced dimension is within the limits shown in Figure 1. Contact Crosby Engineering to evaluate any crack.
- Remove from service any hook which has threads corroded more than 20% of the nut engagement length.
- Never repair, alter, rework, or reshape a hook by welding, heating, burning, or bending.
- Never side load, back load, or tip load a hook. (Side loading, back loading and tip loading are conditions that damage and reduce the capacity of the hook). (See Figure 2.)
- Eye hooks, shank hooks and swivel hooks are designed to be used with wire rope or chain. Efficiency of assembly may be reduced when used with synthetic material.
- Do not swivel the S-322 or S-3319 swivel hooks while supporting a load. These hooks are distinguishable by hex nuts and flat washers.
- The S-3322 swivel hook is designed to rotate under load. The S-3322 is distinguishable from the S-322 by use of a round nut designed to shield bearing.
- The frequency of bearing lubrication on the S-3322 depends upon frequency and period of product use as well as environmental conditions, which are contingent upon the user's good judgement.
- The use of a latch may be mandatory by regulations or safety codes; e.g., OSHA, MSHA, ANSI/ASME B30, Insurance, etc.. (Note: When using latches, see instructions in "Understanding: The Crosby Group Warnings" for further information.)
- Always make sure the hook supports the load. (See Figure 3). The latch must never support the load (See Figure 4).
- When placing two (2) sling legs in hook, make sure the angle from the vertical to the outermost leg is not greater than 45 degrees, and the included angle between the legs does not exceed 90 degrees* (See Figure 5).
- Reference Crosby's Hoist Hook Warning and Application Information for basic machining and minimum thread size.
- See ANSI/ASME B30.10 "Hooks" for additional information.

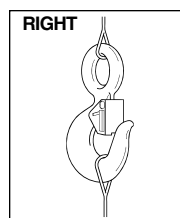
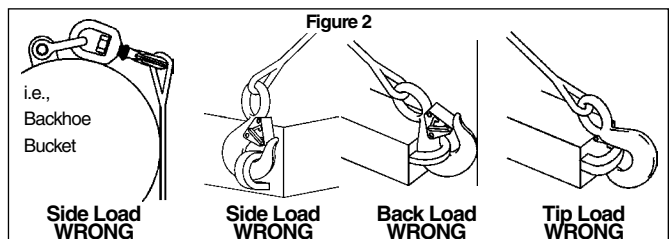
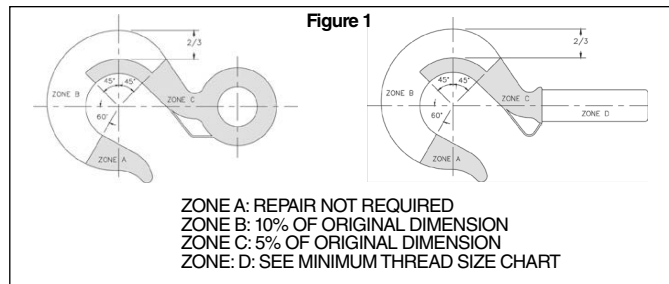

Figure 3

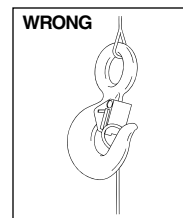

Figure 4

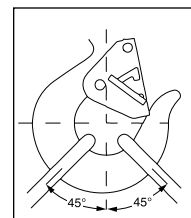

Figure 5

* For two legged slings with angles greater than 90 degrees, use an intermediate link such as a master link or bolt type shackle to collect the legs of the slings. The intermediate link can be placed over the hook to provide an in-line load on the hook. This approach must also be used when using slings with three or more legs.

Removal of Split-Nut assembly (Reference Figure A):

- Remove vinyl cover.
- Remove spring retaining ring.
- Slide steel keeper ring off split nuts **▲ (CAUTION: Removal of keeper ring will allow split nut halves to fall from hook shank).**
- Remove split nut halves.

Inspection of split nut assembly and hook shank interface area (Reference Figure B):

- Inspect hook shank and split nut for signs of deformation on and adjacent to the load bearing surfaces.
- Inspect outside corner of hook shank load bearing surface to verify the corner is sharp.
- Verify retaining ring groove will allow proper seating of the retaining ring.
- Inspect retaining ring for corrosion or deformation. Remove from service any retaining ring that has excessive corrosion or is deformed.
- Use fine grit emery or crocus cloth to remove any corrosion from machined hook shank and split nut assembly.
- Follow inspection recommendations listed in this document under IMPORTANT SAFETY INFORMATION.
- If corrosion is present on the nut / shank interface area and deterioration or degradation of the metal components is evident, further inspection is required.
 - The use of a feeler gauge is required to properly measure the maximum allowable gap width between the split nut inside diameters and shank outside diameters.
 - With one split nut half seated against the hook shank, push the nut to one side and measure the maximum gaps as shown in Figure B. The hook should be measured in four places, 90-degrees apart.
 - Repeat above inspection procedure with other half of split nut.
 - Remove from service any hook and split nut assembly that exhibits a gap greater than 0.030”

Installation of split nut assembly (Reference Figure A):

- Coat hook shank and inside of split nut with an anti-seize compound or heavy grease.
- Install split nut halves onto shank. The flanged bottom of the split nut should be closest to the hook shoulder.

- Slide steel keeper ring over split nut halves. Verify the split nut halves properly seat against the load bearing surface of the hook shank and the steel keeper ring seats against the flange of the split nut.
- Install retaining ring onto split nut halves. Verify the retaining ring seats properly in the retaining ring groove on the outside diameter of the split nut assembly.
- Install vinyl cover over split nut and hook shank assembly.
- Verify all fasteners are correctly installed.
- Always use Genuine Crosby replacement parts.

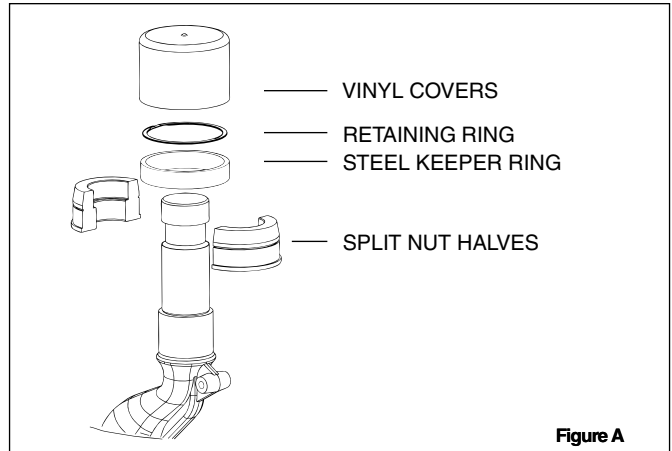

Figure A

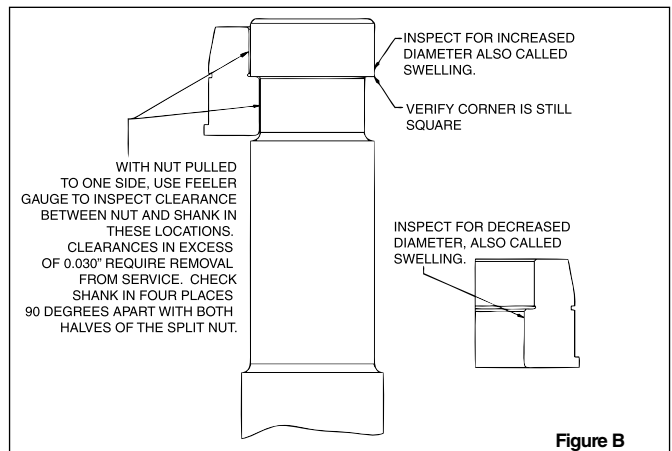
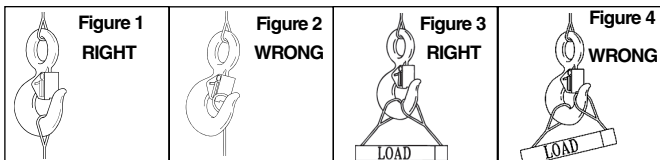

Figure B

Warning and Application Instructions For Crosby® Hook Latch Kit

Important Safety Information – Read & Follow

- Always inspect hook and latch before using.
- Never use a latch that is distorted or bent.
- Always make sure spring will force the latch against the tip of the hook.
- Always make sure hook supports the load. The latch must never support the load. (See Figure 1 & 2)
- When placing two (2) sling legs in hooks, make sure the angle between the legs is less the 90° and if the hook or load is tilted, nothing bears against the bottom of this latch. (See Figures 3 & 4)
- Latches are intended to retain loose sling or devices under slack conditions.
- Latches are not intended to be an anti-fouling device.



▲ WARNING

- Loads may disengage from hook if proper procedures are not followed.
- A falling load may cause serious injury or death.
- See OSHA Rule 1926.1431(g)(1)(i)(A) and 1926.1501(g)(4)(iv)(B) for personnel hoisting for cranes and derricks. Only a Crosby or McKissick hook with a PL Latch attached and secured with bolt, nut and cotter (or Crosby Toggle Pin) or a Crosby hook with a S-4320 Latch attached and secured with a cotter pin, or a Crosby SHUR-LOC® hook in the locked position may be used for any personnel hoisting. A hook with a Crosby SS-4055 latch attached shall NOT be used for personnel lifting.
- Hook must always support the load. The load must never be supported by the latch.
- DO NOT use this latch in applications requiring non-sparking.
- Read and understand these instructions before using hook and latch.