



Sparex

Your 1st choice

S.166343



Wired



Max 4 cameras



7" HD



+70°C
-20°C
Operating temperature



HD Digital Wired System User Manual

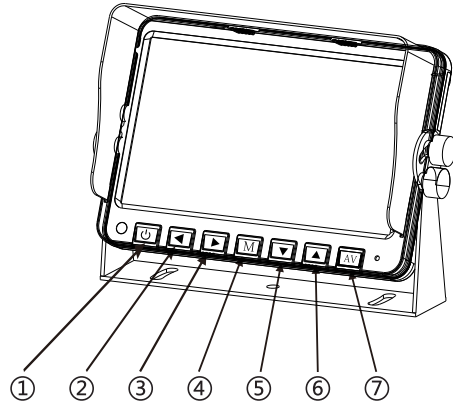

- ① Power
- ② Left(Vol-)
- ③ Right(Vol+)
- ④ Menu
- ⑤ Down
- ⑥ Up
- ⑦ Channel selection

Power Connection

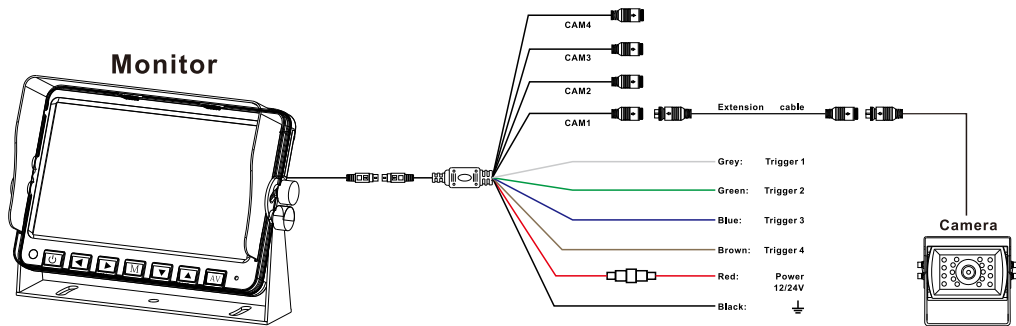

Declaration of Conformity

Name of supplier: Sparex Group
 Manufacturer: Guangzhou Besyo Auto Parts CO.,LTD
 Supplier of address: Exeter Airport, Devon EX5 2LJ, United Kingdom
 Manufacturer: 1208, The 12th Floor, Xiangyun Building, NO.1400 Baiyun Avenue, Baiyun District, Guangzhou,P.R.C

CE Declaration of Conformity compliance with the council EMC Directive 2014/30/EU.





RoHS Declaration of Conformity compliance with the council RoHS directive 2011/65/EU its amendment Directive EU 2015/863

E9 Declaration of Conformity concern of a type of electronic sub-assembly with regard to ECE Regulation No. 10.05.

UK CA Declaration of Conformity in accordance with Regulation 43 of the Electromagnetic Compatibility Regulations 2016 (SI 2016 No. 1091, as amended).

With amendment of the EC Directives and Standards, this declaration is valid for each unit of this article which is delivered to Sparex Ltd

Article Name: Monitor
 Supplier's Article No.: BY-08477M
 Sparex Article No.: S.166343

Implemented harmonized, Standard according to	CE(EMC) <u>EN 50498:2010</u>	RoHS <u>IEC62321-1:2013</u>	E9 <u>ECE No. 10.05</u>	UKCA <u>EN 55032:2015+A11:2020</u> <u>EN 55035:2017</u>
Official Agency:	<u>Shenzhen DL Testing Technology Co., Ltd</u> <u>DL-20210419017C</u>	<u>Shenzhen DL Testing Technology Co., Ltd</u> <u>DL-2019061761C</u>	<u>IDIADA Automotive Technology, S.A.</u> <u>E9-10R-05.16059</u>	<u>Element Materials Technology Warwick Ltd</u> <u>EMA21UKEMC0006</u>
Certificate No.:				
Date of Issue:	<u>Apr. 20, 2021</u>	<u>Jun. 10, 2019</u>	<u>Jan. 18, 2018</u>	<u>Mar.22,2021</u>
Signature with Company Chop:				
Typed name/title of authorized person	<u>Jade Yang</u> <u>/Manager</u>	<u>Jade Yang</u> <u>/Manager</u>	<u>Kent Lian/Auditor</u> <u>Lluís Sana Gomis</u> <u>/Department Manager</u>	<u>Josh Batty/Deputy Certification Manager</u>







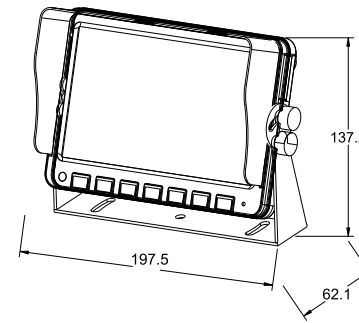

Designed & Importer by:
 Sparex Group
 Exeter Airport
 Devon EX5 2LJ
 United Kingdom

Sparex France
 Z.A.E de Ty douar
 29450 Commana
 France

Manufactured by:
 Guangzhou Besyo Auto Parts CO., LTD
 1208, The 12th Floor, Xiangyun Building,
 NO.1400 Baiyun Avenue, Baiyun District, Guangzhou.
 People Republic of China

Feature



Monitor	
	7" HD
	800*R.G.B.*480
	Yes
	IP54
	500:1
	450cd/m ²
	-20°C ~ 70°C -68°F ~ 158°F
	10G
	12/24V

Applications

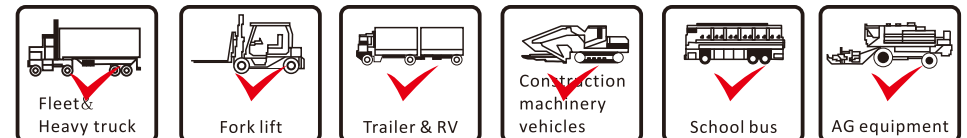
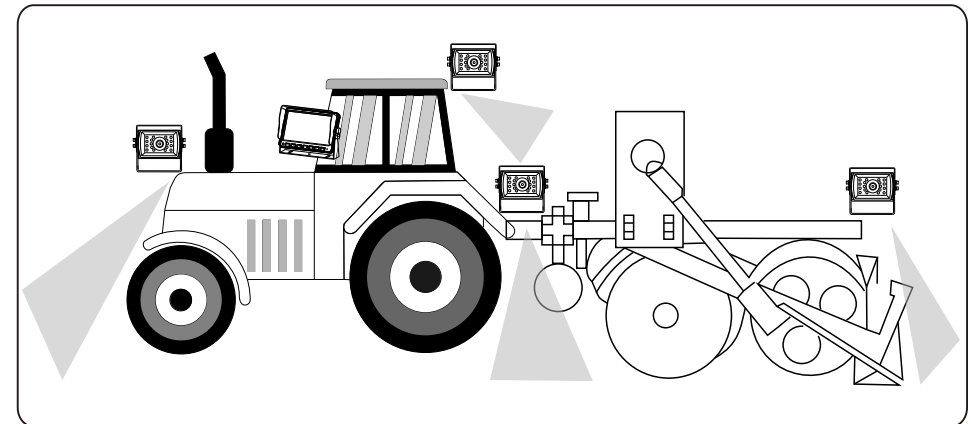

Monitor Menu

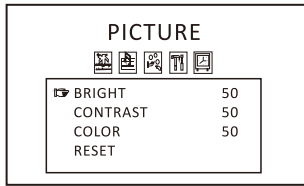

1) Picture:

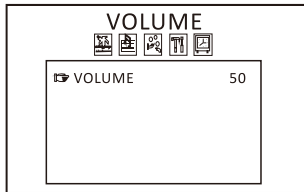
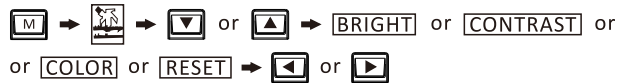

2) Volume:

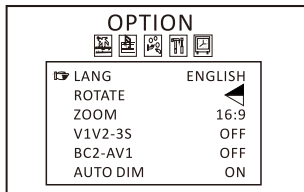

3) Option:

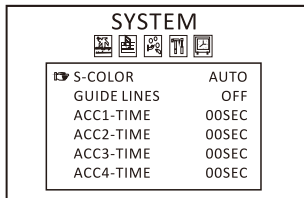
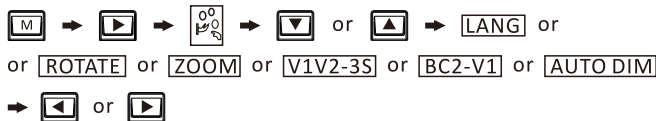

4) System:

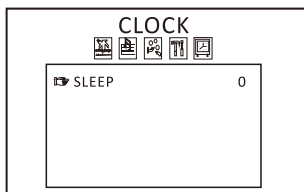
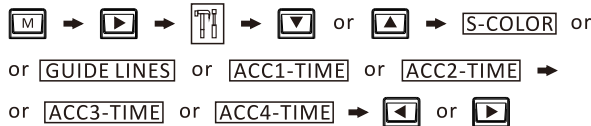

5) Clock:



- GB** The system maintenance must be maintained by professionals, please do not open and improve the system! The system is only for the safe operation of equipment and not responsible for accidents! This manual is for reference only. If unknown, or any changes, we will give no notice. The final interpretation right belongs to the manufacturer.
- ES** El mantenimiento del sistema debe ser realizado por profesionales. No intente abrir ni mejorar el sistema. El sistema es solo para el funcionamiento seguro del equipo y no es responsable de accidentes. Este manual es solo para referencia. No lo notificaremos de cambios o aspectos desconocidos. El derecho de la interpretación final le pertenece al fabricante.
- NL** Het systeem onderhoud moet worden onderhouden door professionals, gelieve niet te openen en het systeem te verbeteren! Het systeem is alleen voor de veilige werking van de apparatuur en niet verantwoordelijk voor ongelukken! Deze handleiding is alleen ter referentie. Indien er onbekende dingen gebeuren, of wijzigingen zijn, zullen wij u niet contacteren. Het uiteindelijke oordeel berust bij de fabrikant.
- FR** L'entretien du système doit être effectué par des professionnels, veuillez ne pas ouvrir et améliorer le système ! Le système est seulement destiné au fonctionnement sûr de l'équipement et ne peut être tenu responsable des accidents ! Ce manuel est seulement à titre de référence. En cas d'inconnu, ou de tout changement, nous ne donnerons aucun préavis. Le droit d'interprétation final appartient au fabricant.
- DE** Die Systemwartung muss von Fachleuten durchgeführt werden, bitte das System nicht selbstständig öffnen und keine Verbesserungsversuche vornehmen! Das System dient nur für den sicheren Betrieb von Geräten und wir übernehmen keine Haftung für jegliche Unfälle! Dieses Handbuch dient nur als Referenz. Wir behalten uns das Recht auf jegliche Änderungen ohne Ankündigung vor. Das Recht auf die endgültige Auslegung liegt beim Hersteller.
- DK** Systemvedligeholdelse skal vedligeholdes af fagfolk. Du må ikke åbne og forsøge at forbedre systemet! Systemet er kun beregnet til sikker betjening af udstyret og er ikke ansvarligt for ulykker! Denne vejledning er kun til reference. Hvis det er ukendt eller der er ændringer, giver vi ingen besked. Den endelige fortolkningsret tilhører producenten.
- PL** Konserwację systemu mogą przeprowadzać wyłącznie specjaliści, nie wolno otwierać ani ingerować w system! System służy do bezpiecznego obsługi urządzeń, jednak nie gwarantujemy braku wypadków! Niniejsza instrukcja ma znaczenie tylko informacyjne. Nie powiadamy o wprowadzanych zmianach. Prawo do ostatecznej interpretacji należy do producenta.
- IT** La manutenzione del sistema deve essere effettuata da professionisti, si prega di non aprire ed apportare miglioramenti al sistema! Il sistema è progettato per garantire il funzionamento sicuro delle attrezzature e non è responsabile di eventuali incidenti! Questo manuale è solo per riferimento. Per novità, o eventuali modifiche, non daremo alcun preavviso. Il diritto di interpretazione finale appartiene al produttore.
- PT** A manutenção do sistema deve ser realizada por profissionais. Não abra nem modifique o sistema! O sistema destina-se unicamente a operação segura do equipamento e não é responsável por acidentes! Este manual serve unicamente para referência. Se desconhecido ou quaisquer alterações, não enviaremos nenhum aviso. O direito de interpretação final pertence ao fabricante.

Contact Information

Europe			
Austria Tel: +43 4322 6400 Sparex Austria Mauerbergstr. 51 Hirtenhof 9100	Belgium / Lux Tel: +32 2835 130 Sparex Belgium Bvba Toussaintweg 4 B-8020 Nieuwpoort	Denmark Tel: +45 647 22287 Sparex Denmark Mølnerbølgen 57 Mølnervej 1 8600 Aars	Italy Tel: +39 02 8212 6400 Sparex Austria Lorenzoniweg, 20N 23530 Uffonovo-Verona
France Tel: +33 3987 89334 Sparex S.A.R.L. ZAC de l'Ormeau Communa 23640	Germany Tel: +49 4382 98100 Sparex Germany Helmholtzstr. 202 Sittensen 27439	Ireland Tel: +353 1 853582 Sparex (Tractor Accessories) Ltd C/O Conroy & Co. Ltd Waterford Ireland	Netherlands Tel: +31 236 961 020 Sparex Holland B.V. Lorenzoniweg, 20N 2353 UM Nieuw-Vennep
Poland Tel: +48 61 616 19 37 61-108 ul. Rataje 104, Poznan	Spain Tel: +34 91 336 242 Sparex España S.L. C/ Jose Maria No. 15 B 01006 Victoria-Garcera (Alcala)	UK Tel: +44 1293 441338 Sparex Limited Gutteridge Drive Easter ERS 2U	
North America		Africa	
Canada Tel: +1 905 788 237 Sparex Canada Highway No. 2 On Newmarket 11B 119	Australia Tel: +1 310 8288130 Sparex US PO Box 150 Aurora, OH 44202	South Africa Cape Town 4296 Tel: +27 21 573 2400 Cape Town 35 George Blako St Pippenberg Stellenbosch 7600	South Africa 4296 Harsham 59 Marcellus crescent Bridford Durban 4001
Australia		New Zealand	
Australia Tel: +61 7 399 200 379 Sparex Australia Pty Ltd E.L.B. Strickland Avenue Sunshine West, VIC 3020	New Zealand Tel: +64 7648 4113 Sparex Agriproducts S.L./Coastal 4 Princes Street Dunstons Auckland 1140	Sparex Export Markets Export Sparex Limited Gutteridge Drive Easter ERS 2U	